

SHREENATHJI EXTRUSION

SEC. NO:-14036
SEC. NO:- P-12

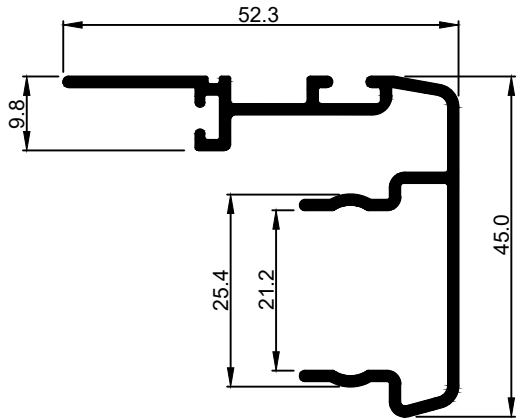

WEIGHT:- 2.200-2.400 kg/12'

SEC. NO:-14026
SEC. NO:- P-33

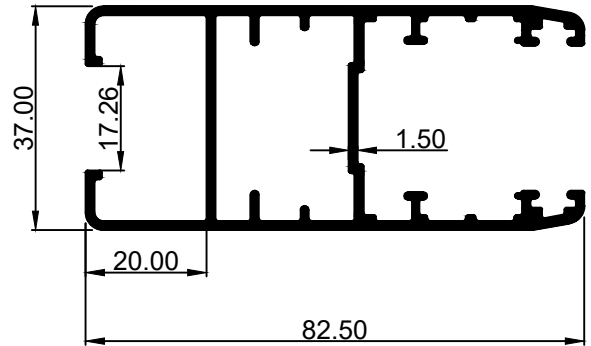

WEIGHT:- 4.600-4.900 kg/12'

SEC. NO:- P-13
SEC. NO:-14061

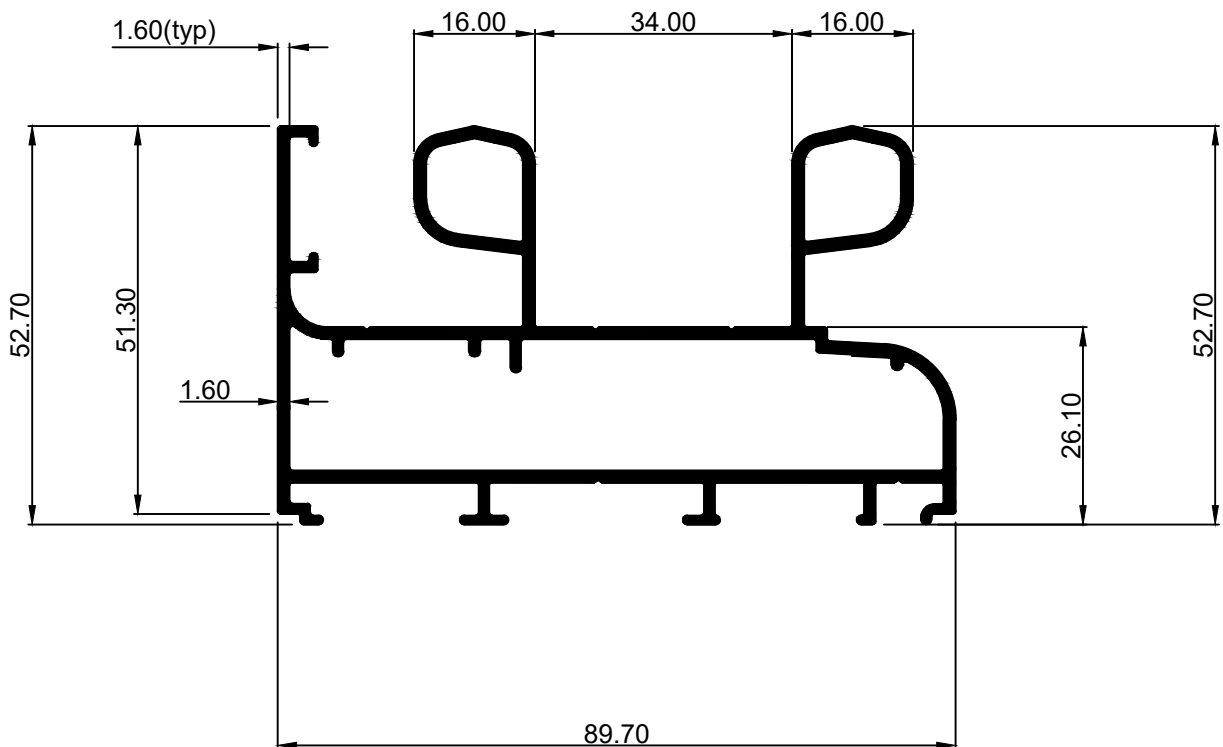

WEIGHT:- 6.400-6.700 kg/12'

SHREENATHJI EXTRUSION

SEC. NO:-14066
SEC. NO:- P-26

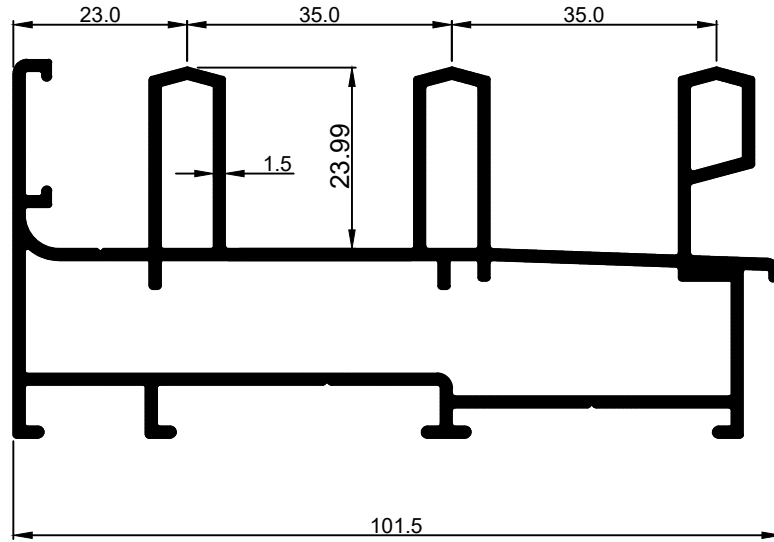

WEIGHT:- 6.900-7.200 kg/12'

SEC. NO:-14071
SEC. NO:- P-27

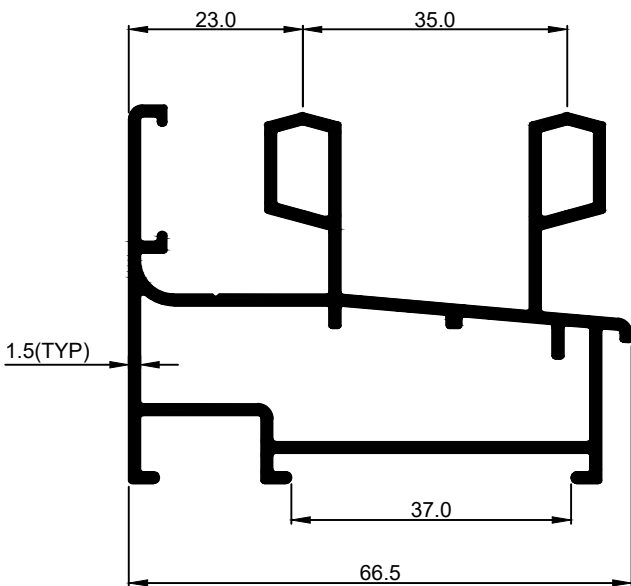

WEIGHT:- 4.800-5.100 kg/12'

SEC. NO:-16378

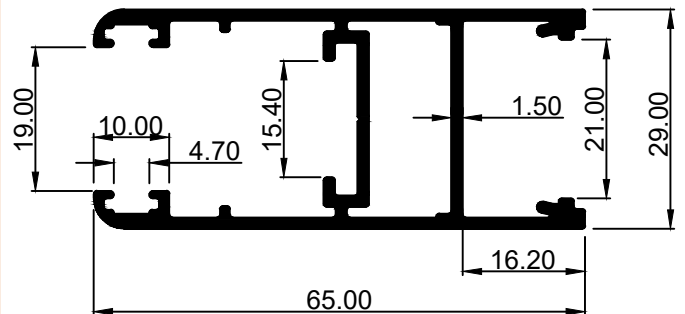

WEIGHT:- 3.445 kg/12'

SHREENATHJI EXTRUSION

SEC. NO:-14091
SEC. NO:- P-25

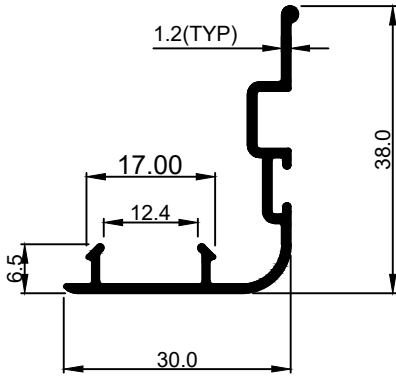

WEIGHT:- 0.950-1.200 kg/12'

SEC. NO:-16021

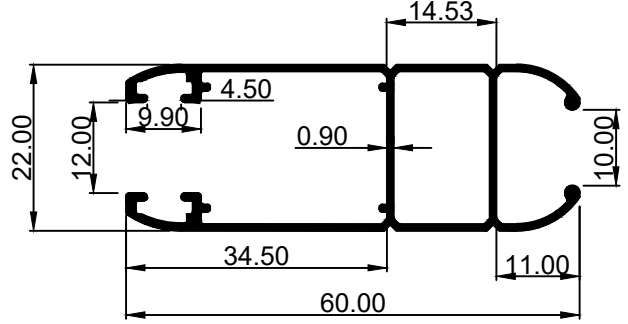

WEIGHT:- 1.773 kg/12'

SEC. NO:-14086
SEC. NO:- P-24

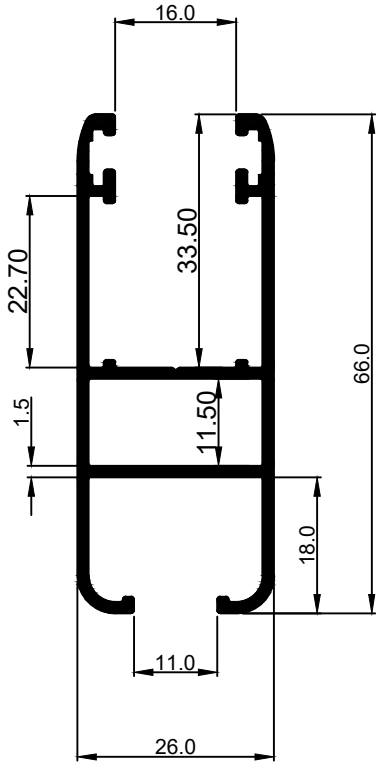

WEIGHT:- 3.000-3.300 kg/12'

SEC. NO:-14096

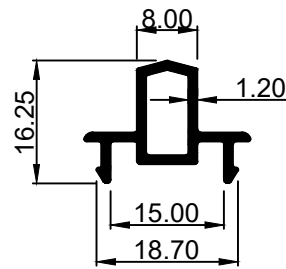

WEIGHT:- 0.700-1.000 kg/12'

SHREENATHJI EXTRUSION

SEC. NO:-15781

N-58/2

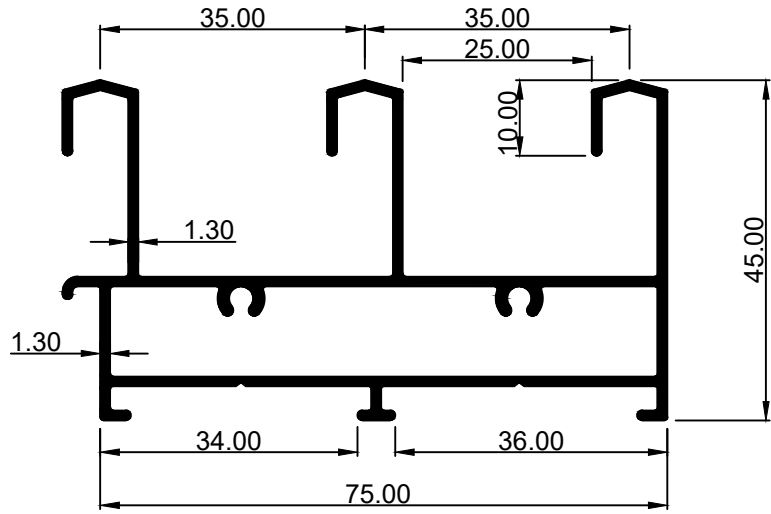

WEIGHT:- 4.427 kg/12'

SEC. NO:-15786

N-58/3

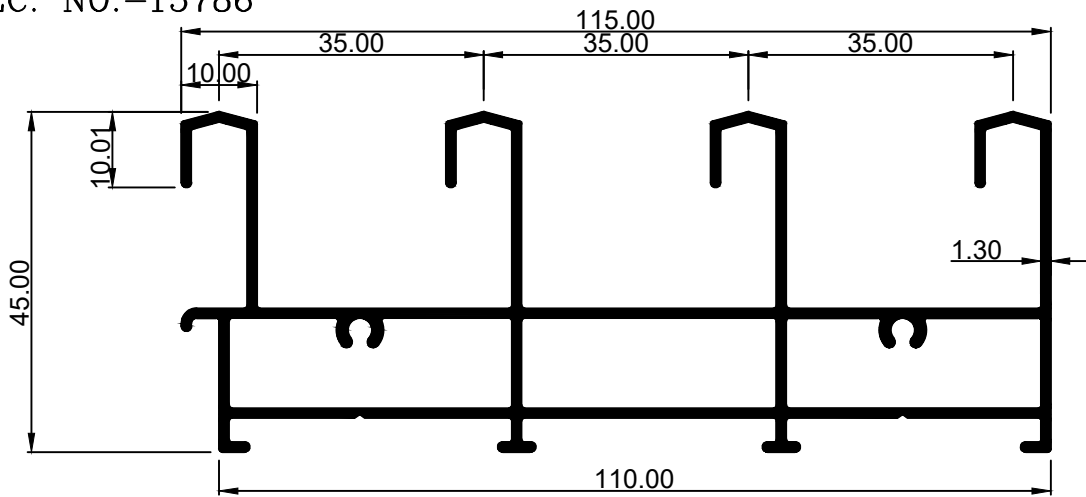

WEIGHT:- 6.262 kg/12'

SEC. NO:-16490

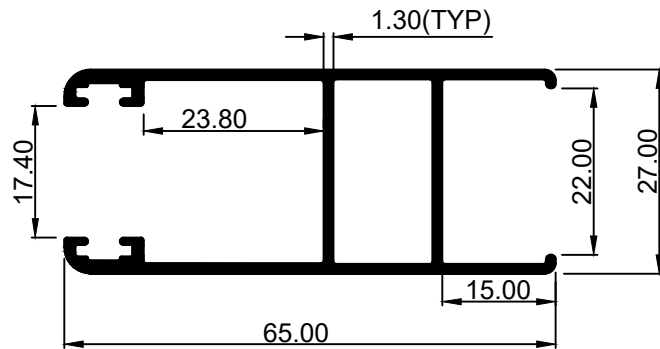

WEIGHT:- 2.688 kg/12'

SHREENATHJI EXTRUSION

SEC. NO:-16133

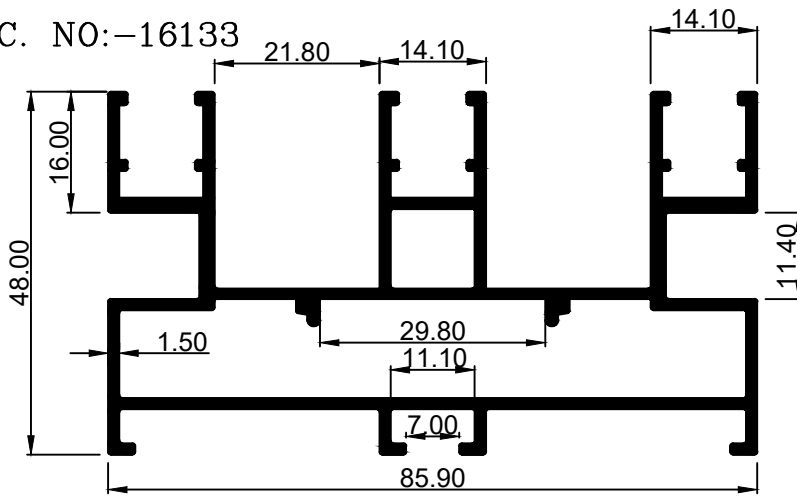

WEIGHT:- 6.466 kg/12'

SEC. NO:-16134

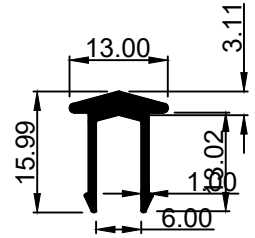

WEIGHT:- 0.552 kg/12'

SEC. NO:-16135

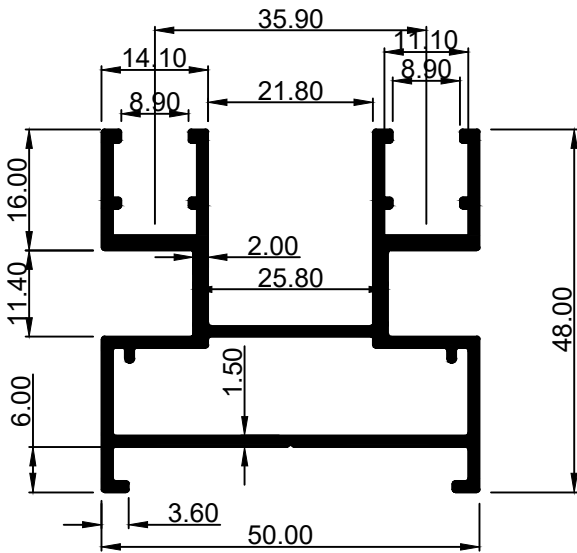

WEIGHT:- 4.065 kg/12'

SEC. NO:-16136

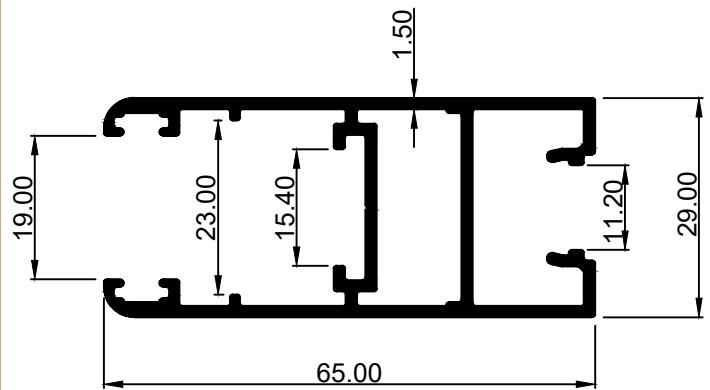

WEIGHT:- 3.553 kg/12'

SEC. NO:-16137

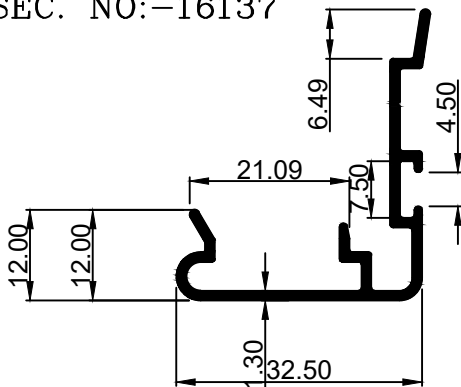

WEIGHT:- 1.333 kg/12'

SEC. NO:-16138

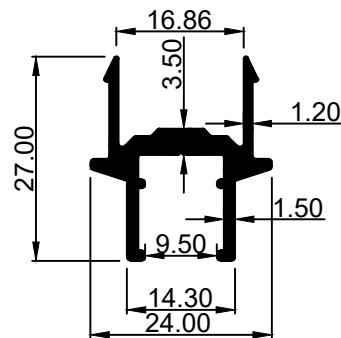

WEIGHT:- 1.434 kg/12'

Shreenathji

Extrusion

23111

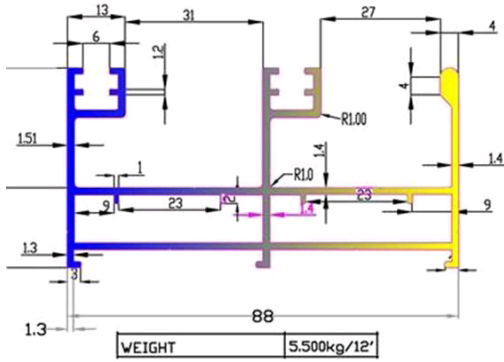

DUMBHAL

23112

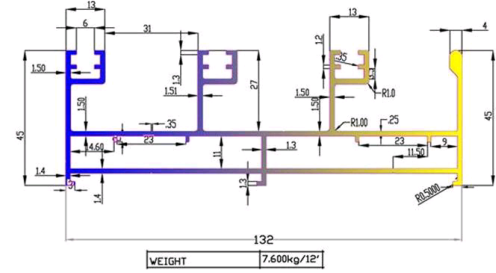

DUMBHAL

23141

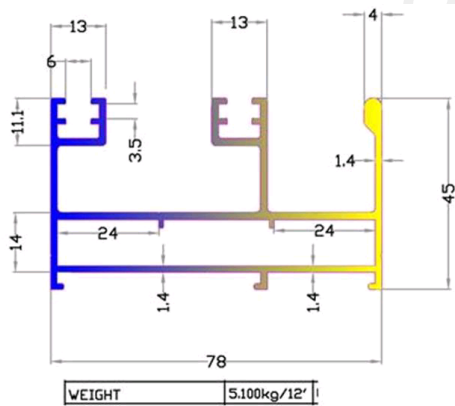

DUMBHAL

23142

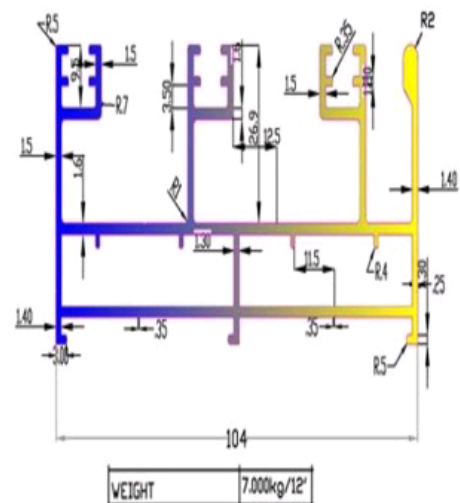

DUMBHAL

Shreenathji

Extrusion

23143

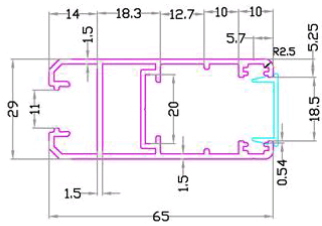

DIE NO-23143
WEIGHT- 3.500kg/12'

DUMBHAL

23144

DIE NO-23144
WEIGHT-3.200kg/12'

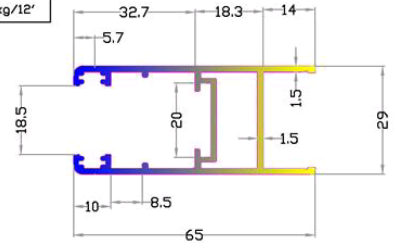

DUMBHAL

30339

SEC. NO:-30339

8009

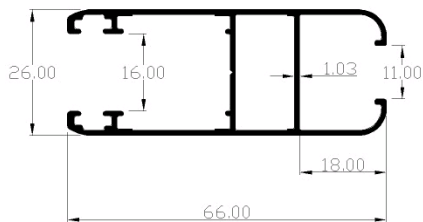

WEIGHT:- 2.448 kg/12'

DUMBHAL

30340

SEC. NO:-30340

8010

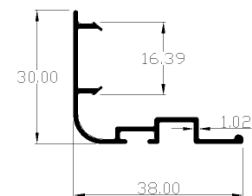

WEIGHT:- 0.934 kg/12'

DUMBHAL

Shreenathji

30341

SEC. NO:-30341

8007

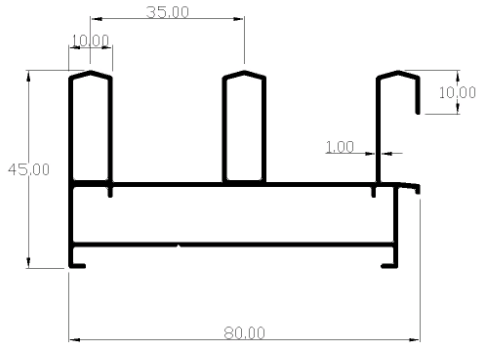

WEIGHT:- 3.637 kg/12'

DUMBHAL

Extrusion

30349

SEC. NO:-30349

8019

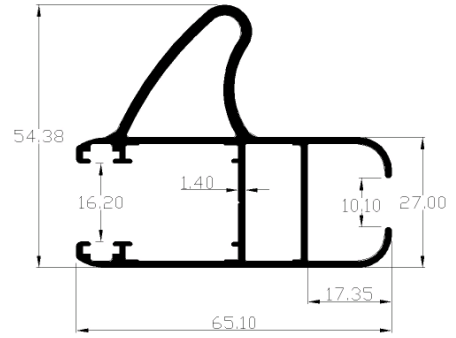

WEIGHT:- 4.362 kg/12'

DUMBHAL

30392

SEC. NO:-30392

8104

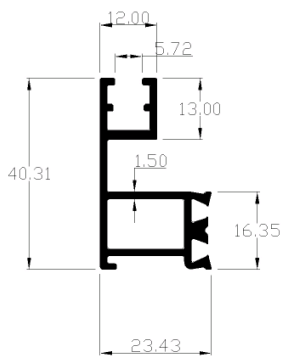

WEIGHT:- 2.100 kg/12'

DUMBHAL

30395

SEC. NO:-30395

8102

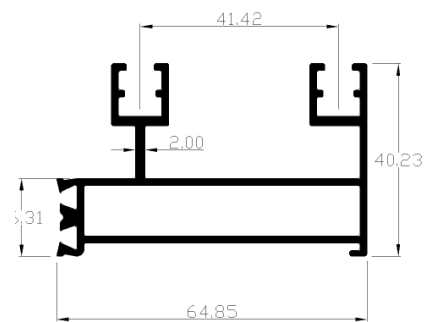

WEIGHT:- 4.194 kg/12'

DUMBHAL

Shreenathji

Extrusion

8056

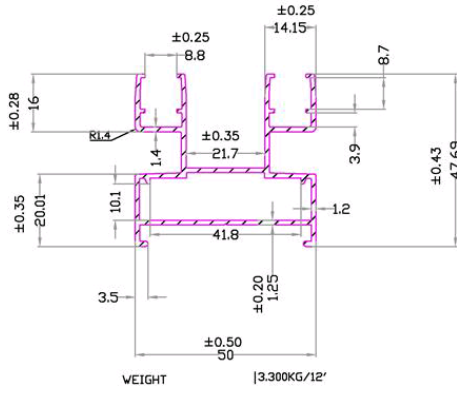

DUMBHAL

8102

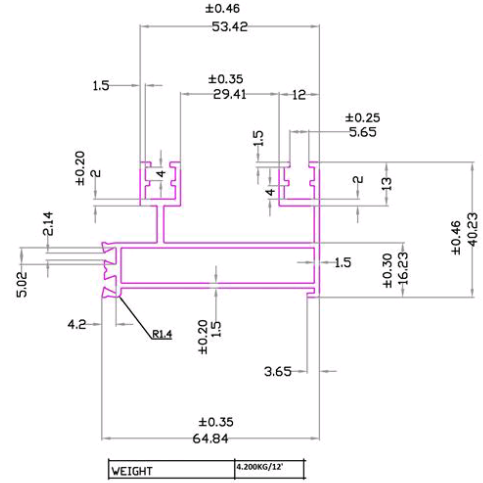

DUMBHAL

8103

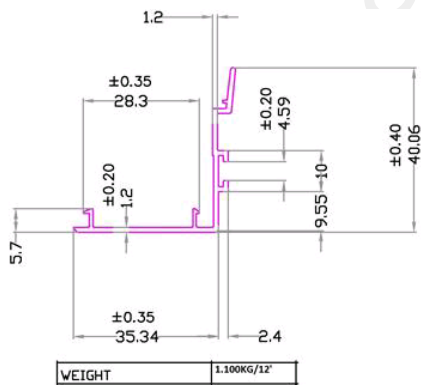

DUMBHAL

8104

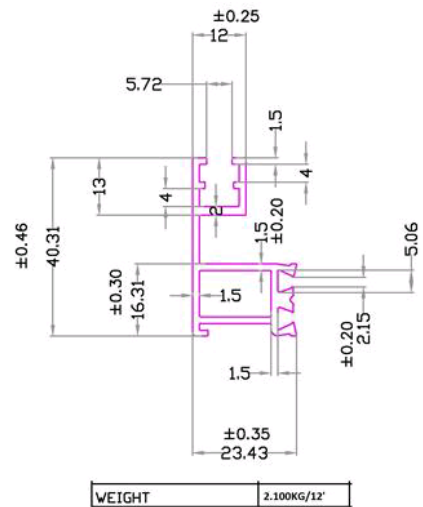

DUMBHAL

Shreenathji

Extrusion

8105

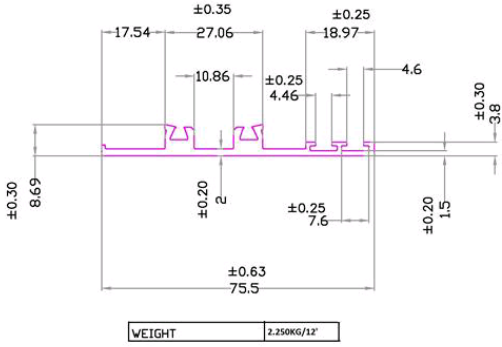

DUMBHAL

8160

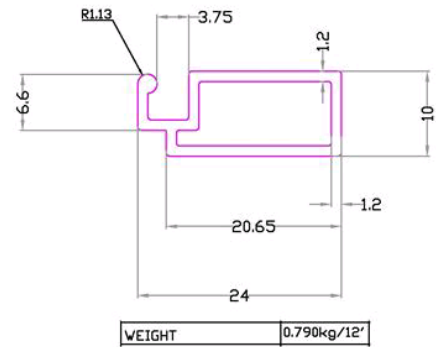

DUMBHAL

8162

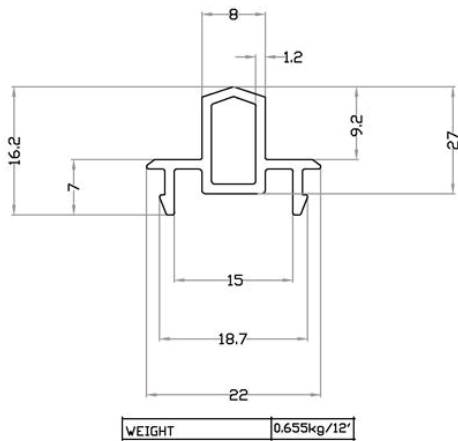

DUMBHAL

8175

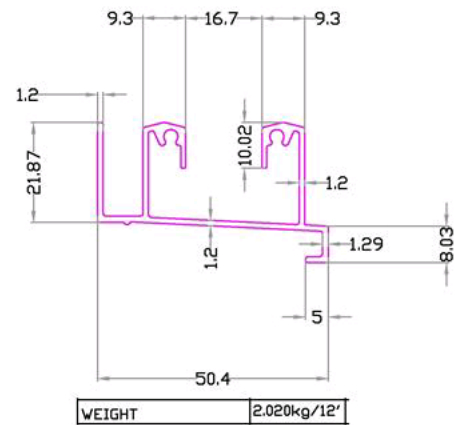

DUMBHAL

Shreenathji

Extrusion

8248

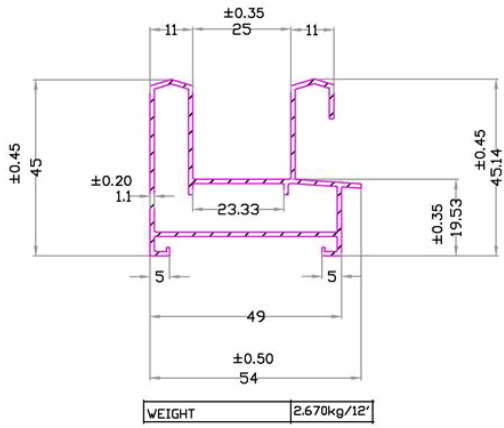

DUMBHAL

8273

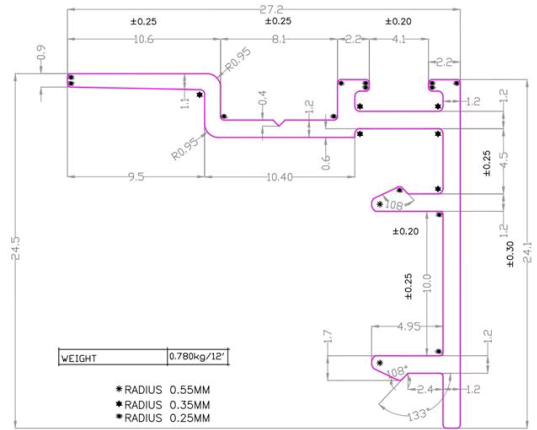

DUMBHAL

8274

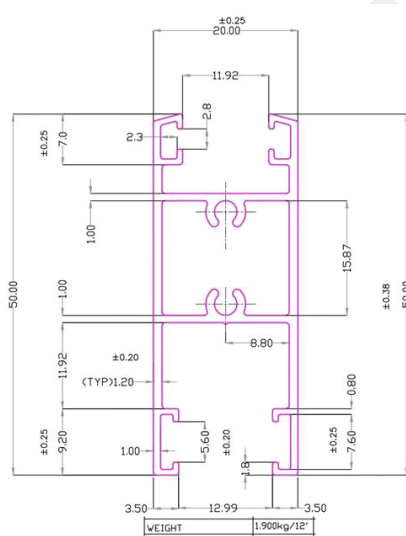

DUMBHAL

8422

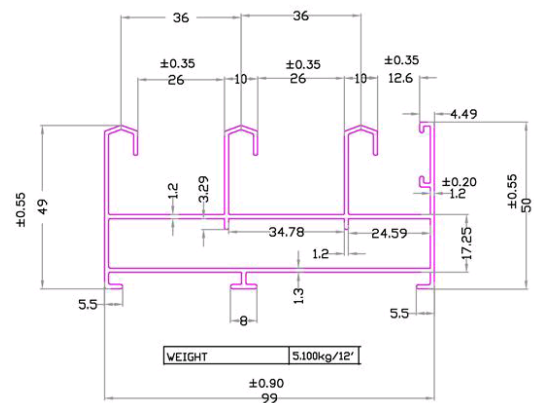

DUMBHAL

Shreenathji

Extrusion

8474

SEC NO : 8474

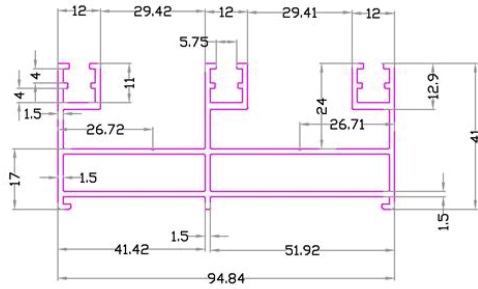

DUMBHAL ,MAAHI ALU

8480

SEC NO:8480

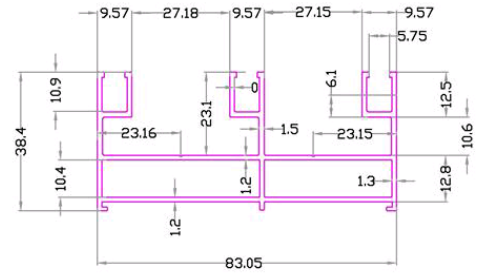

WEIGHT:4.350kg/12'

DUMBHAL

8481

SEC NO:8481

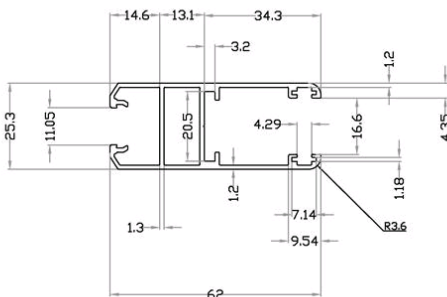

WEIGHT:2.600kg/12'

DUMBHAL

8482

SEC NO:8482

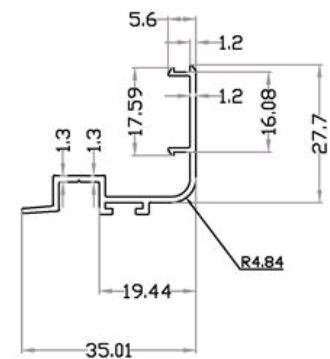

WEIGHT:1.000kg/12'

DUMBHAL

Shreenathji

Extrusion

8483

8498

SEC NO:8483

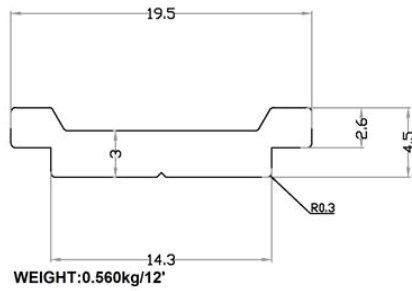

DUMBHAL

SEC NO : 8498

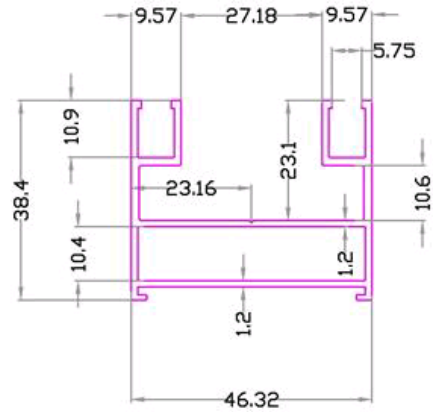

DUMBHAL ,MAAHI ALU

8522

8524

SEC NO : 8522

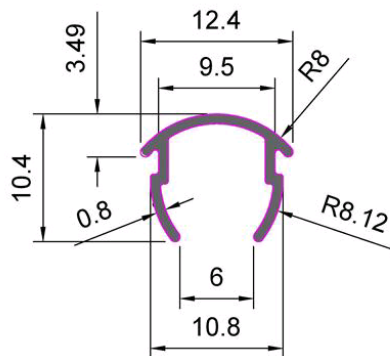

DUMBHAL

SEC NO : 8524

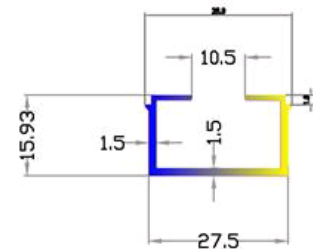

DUMBHAL ,MAAHI ALU

Shreenathji

Extrusion

8525

SEC NO : 8525

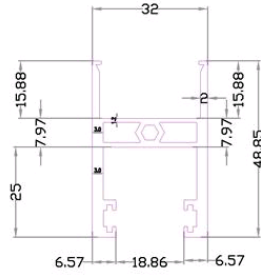

DUMBHAL

8526

SEC NO : 8526

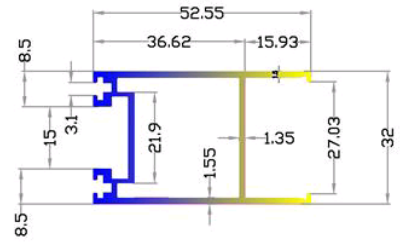

DUMBHAL

8527

SEC NO : 8527

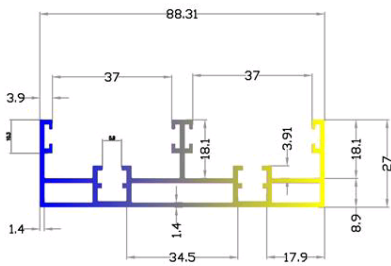

DUMBHAL

8528

SEC NO : 8528

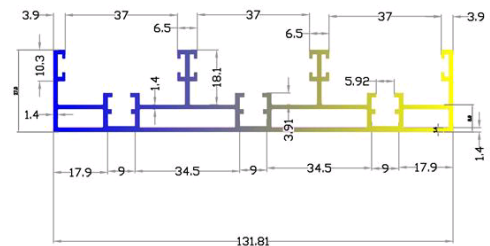

DUMBHAL

Shreenathji

Extrusion

8546

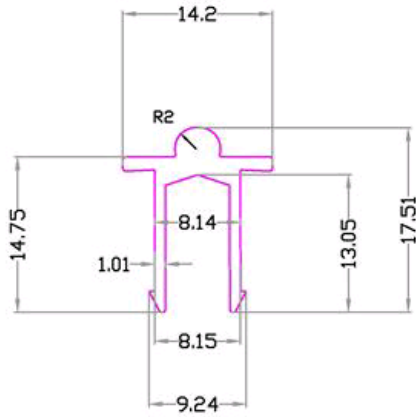

DUMBHAL

8547

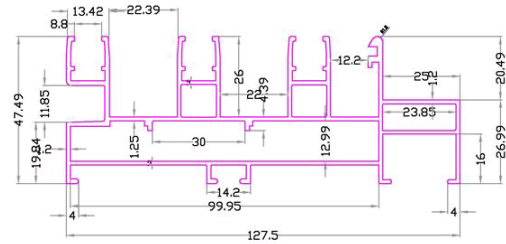

DUMBHAL

8548

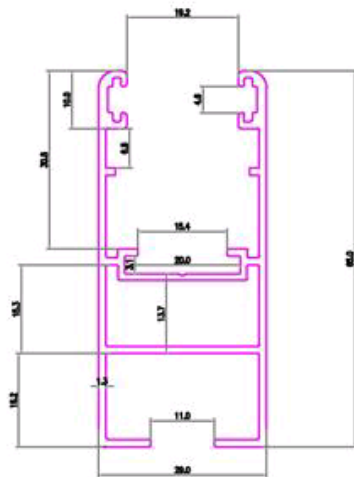

DUMBHAL

8556

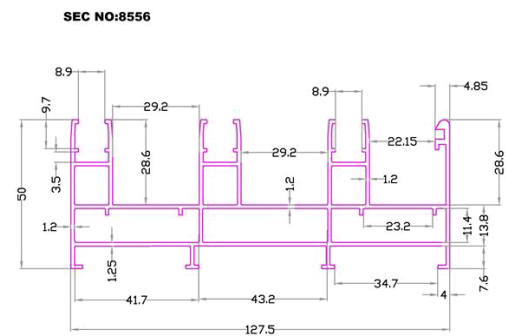

DUMBHAL

Shreenathji

8557

SEC NO:8557

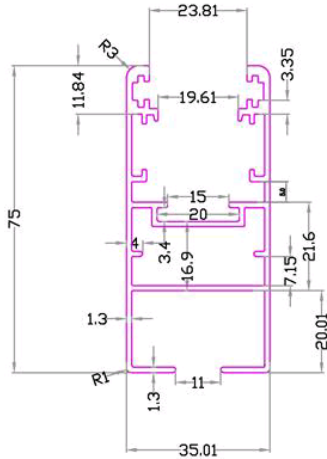

DUMBHAL

Extrusion

8558

SEC NO:8558

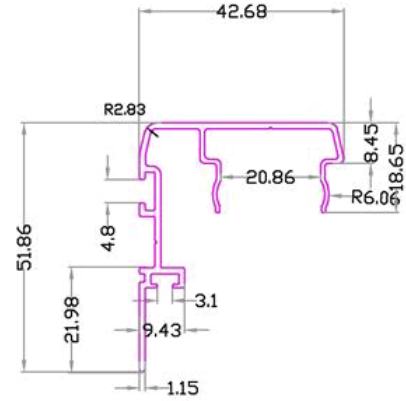

DUMBHAL

8589

SEC NO:8589

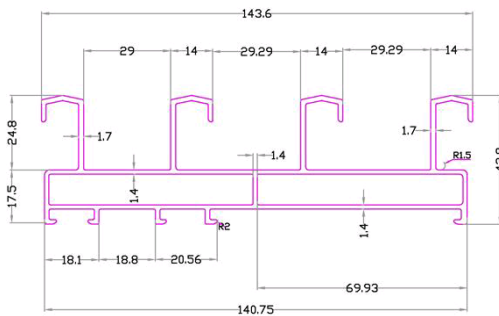

DUMBHAL

8590

SEC NO:8590

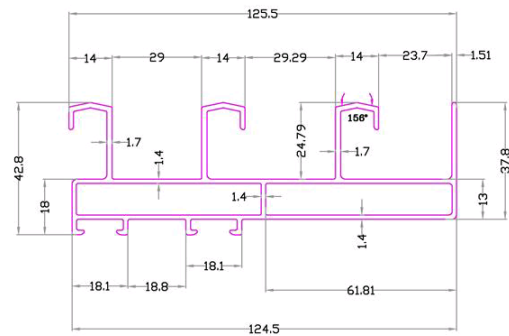

DUMBHAL

Shreenathji

Extrusion

8608

SEC NO : 8608

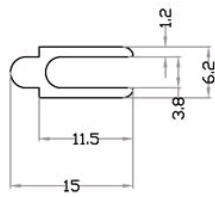

DUMBHAL

8651

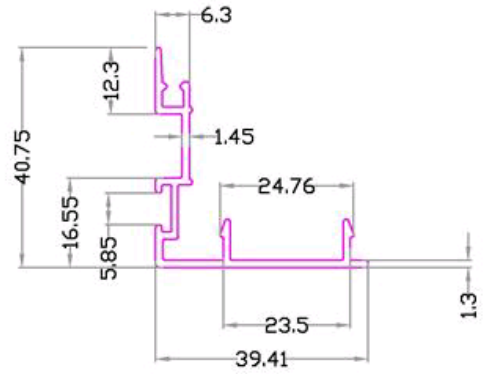

DUMBHAL

8715

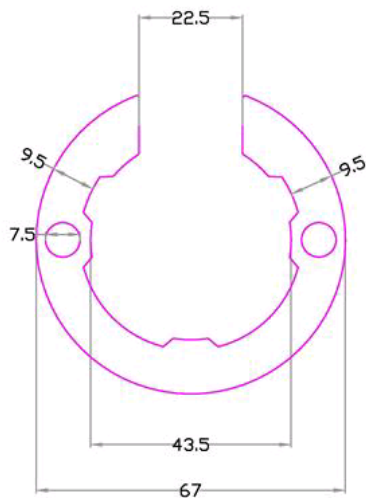

DUMBHAL

8723

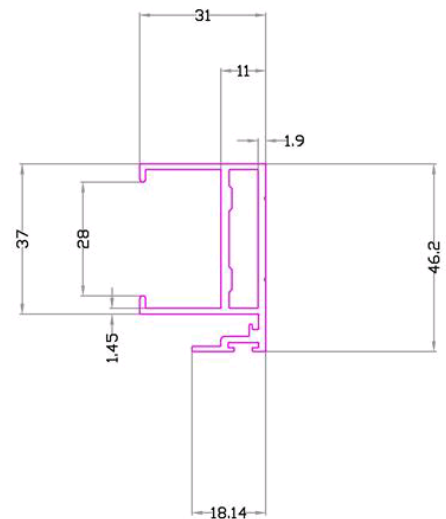

DUMBHAL

Shreenathji

Extrusion

8724

8789

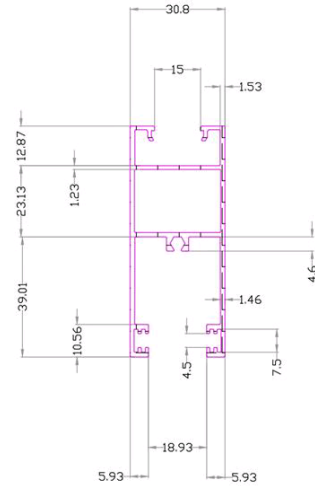
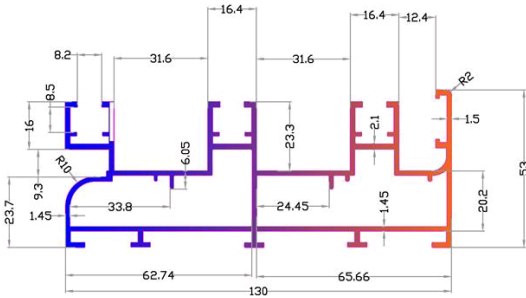

DUMBHAL

DUMBHAL ,MAAHI ALU

8790

8793

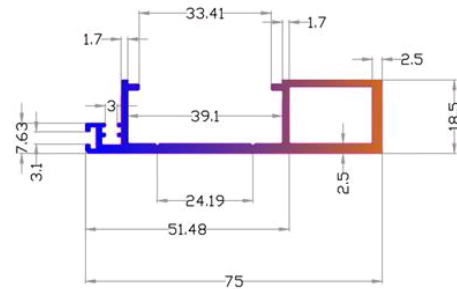
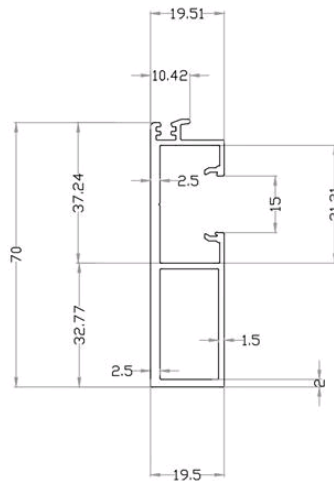

DUMBHAL ,MAAHI ALU

DUMBHAL ,MAAHI ALU

Shreenathji

Extrusion

9090

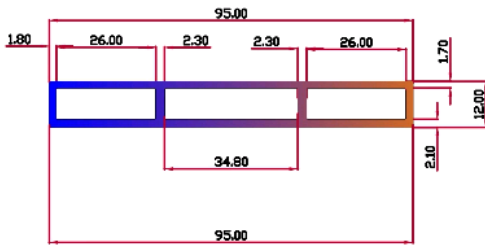

DIE.NO:-9090
WEIGHT:-4.250KG/12'

DUMBHAL

9091

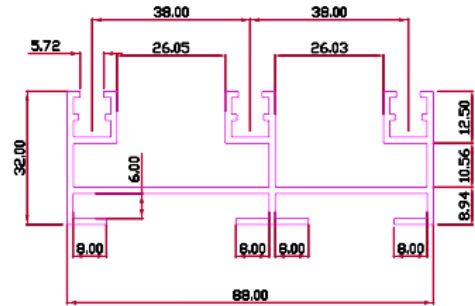

DIE.NO:-9091
WEIGHT:-4.250KG/12'

DUMBHAL ,PLECTRA

9092

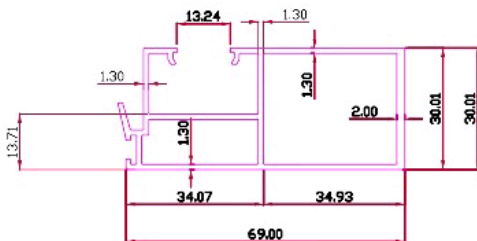

DIE.NO:-9092
WEIGHT:-3.300KG/12'

DUMBHAL

9093

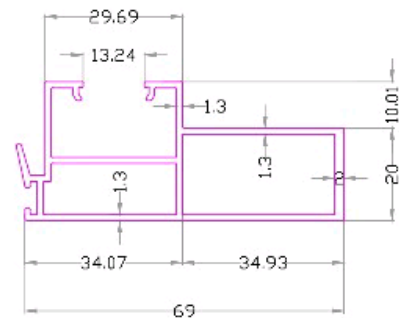

DIE.NO:-9093
WEIGHT:-3.100KG/12'

DUMBHAL

Shreenathji

Extrusion

9096

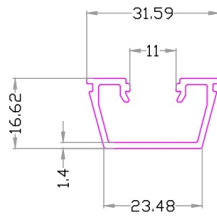

DIE NO-9096
WEIGHT-1.150kg/12'

DUMBHAL

9097

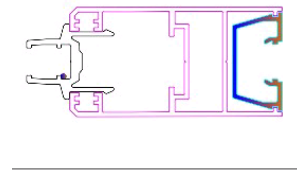

DIE NO-9097
WEIGHT-1.600kg/12'

DUMBHAL

9098

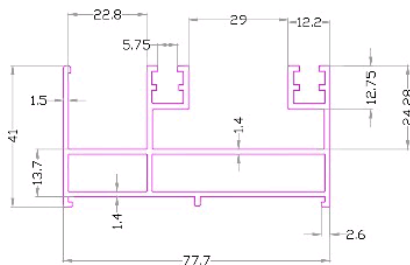

DIE NO-9098
WEIGHT-4.900kg/12'

DUMBHAL

9099

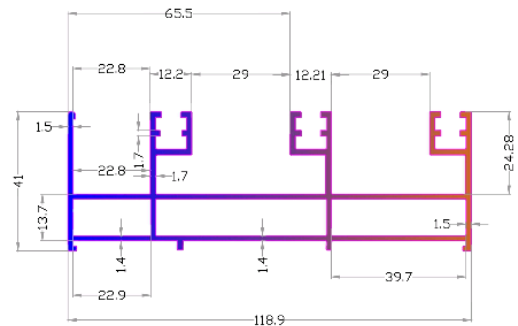

DIE NO-9099
WEIGHT-7.100kg/12'

DUMBHAL

Shreenathji

Extrusion

9130

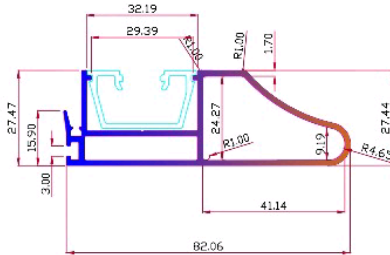

DIE NO-9130
WEIGHT-3.470kg/12'

DUMBHAL

9131

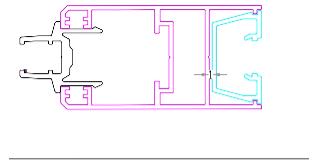

DIE NO-9131
WEIGHT-3.600kg/12'

DUMBHAL

CLIP

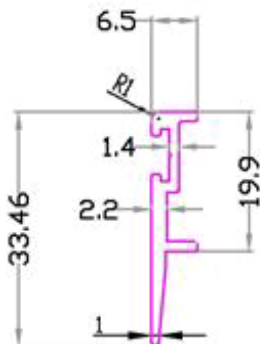

WEIGHT-0.750kg/12'

DUMBHAL

COVER

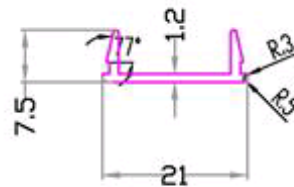

WEIGHT-0.400kg/12'

DUMBHAL

MEETING

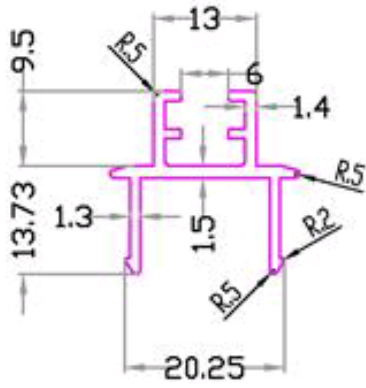

DUMBHAL

Extrusion

Shreenathji