

SHREENATHJI EXTRUSION

SEC. NO:-30180

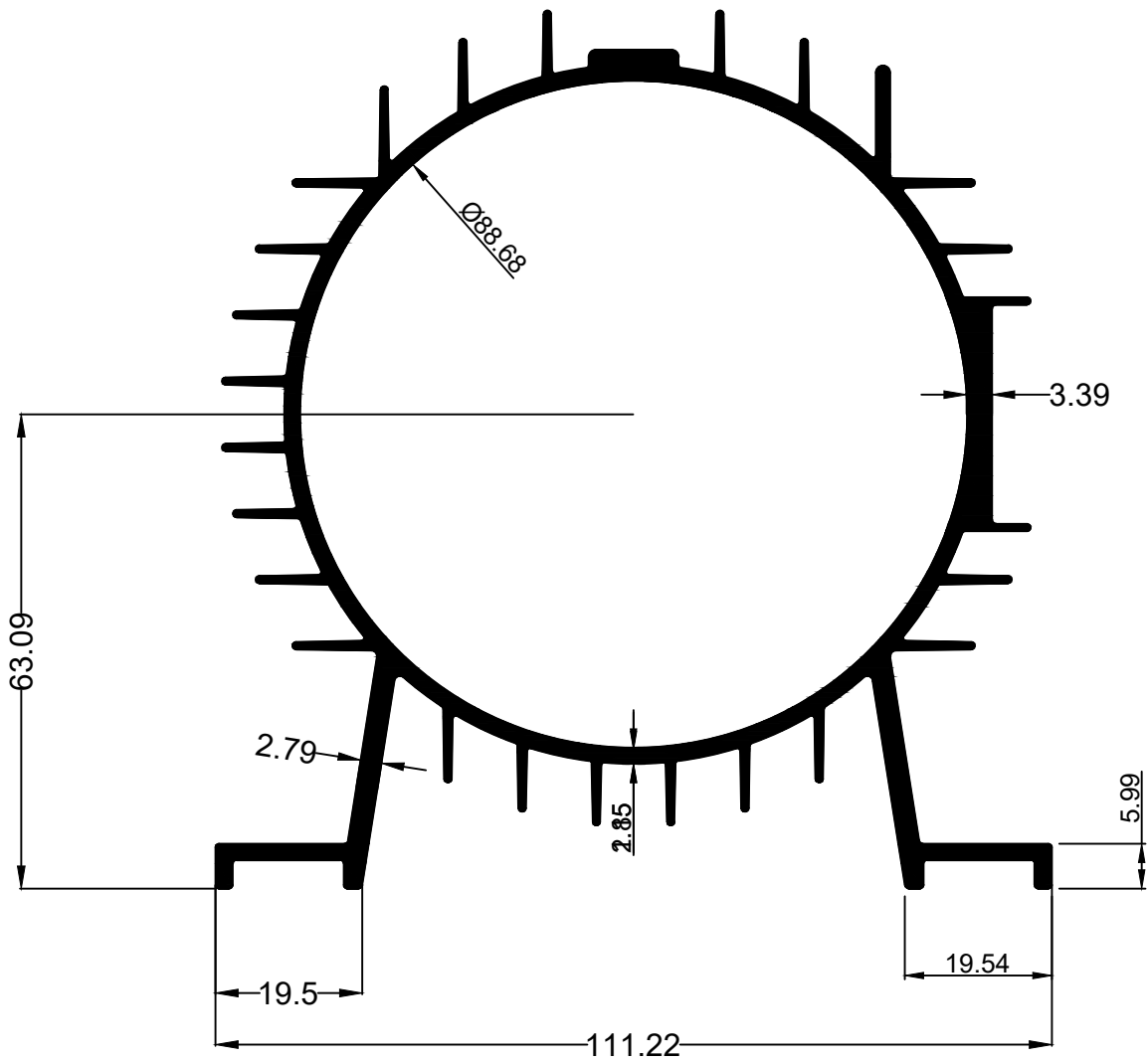

WEIGHT:- 12.346 kg/12'

SHREENATHJI EXTRUSION

SEC. NO:-30229

P-01

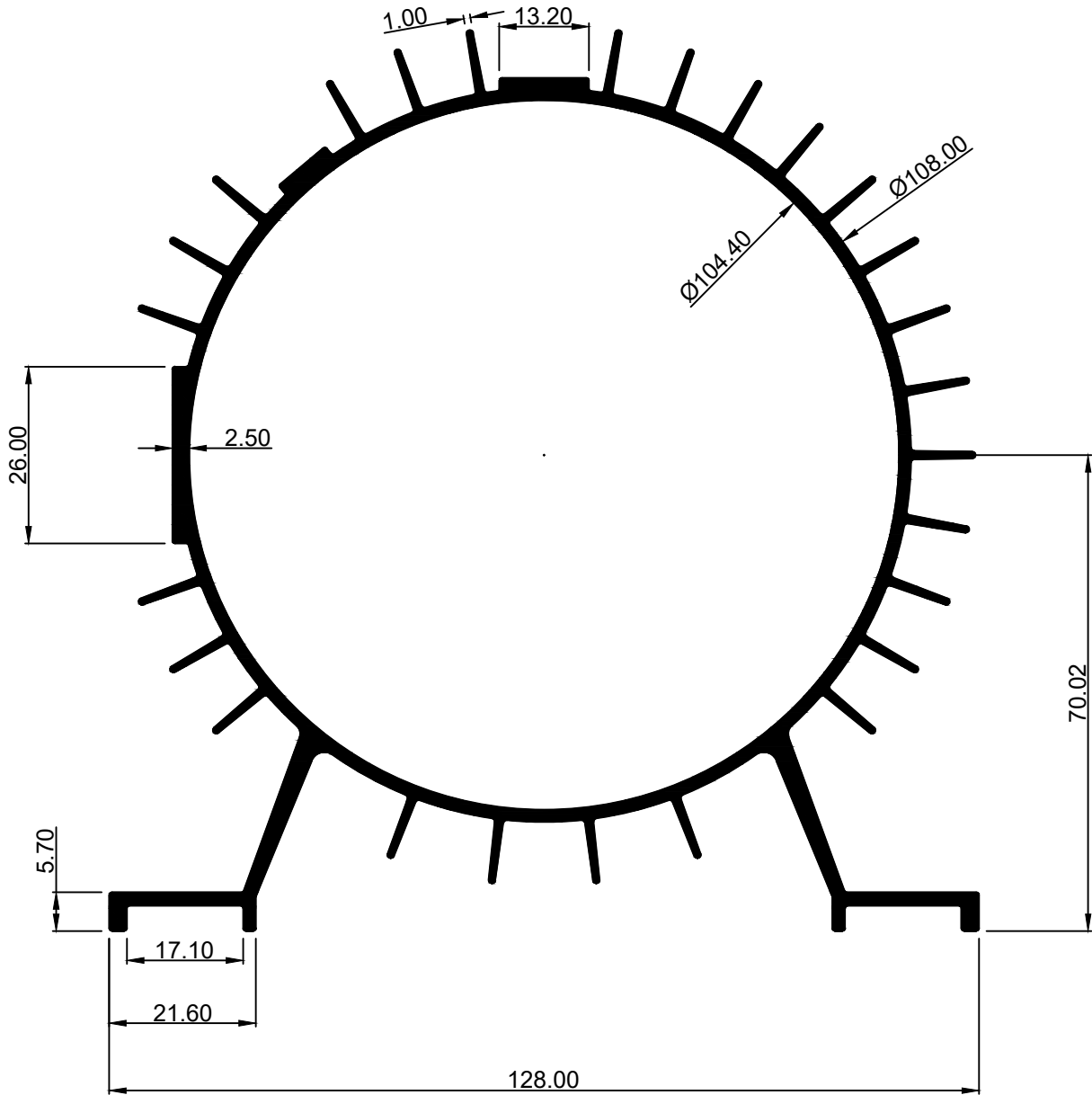

WEIGHT:- 11.835 kg/12'

SHREENATHJI EXTRUSION

SEC. NO:-30499

8268

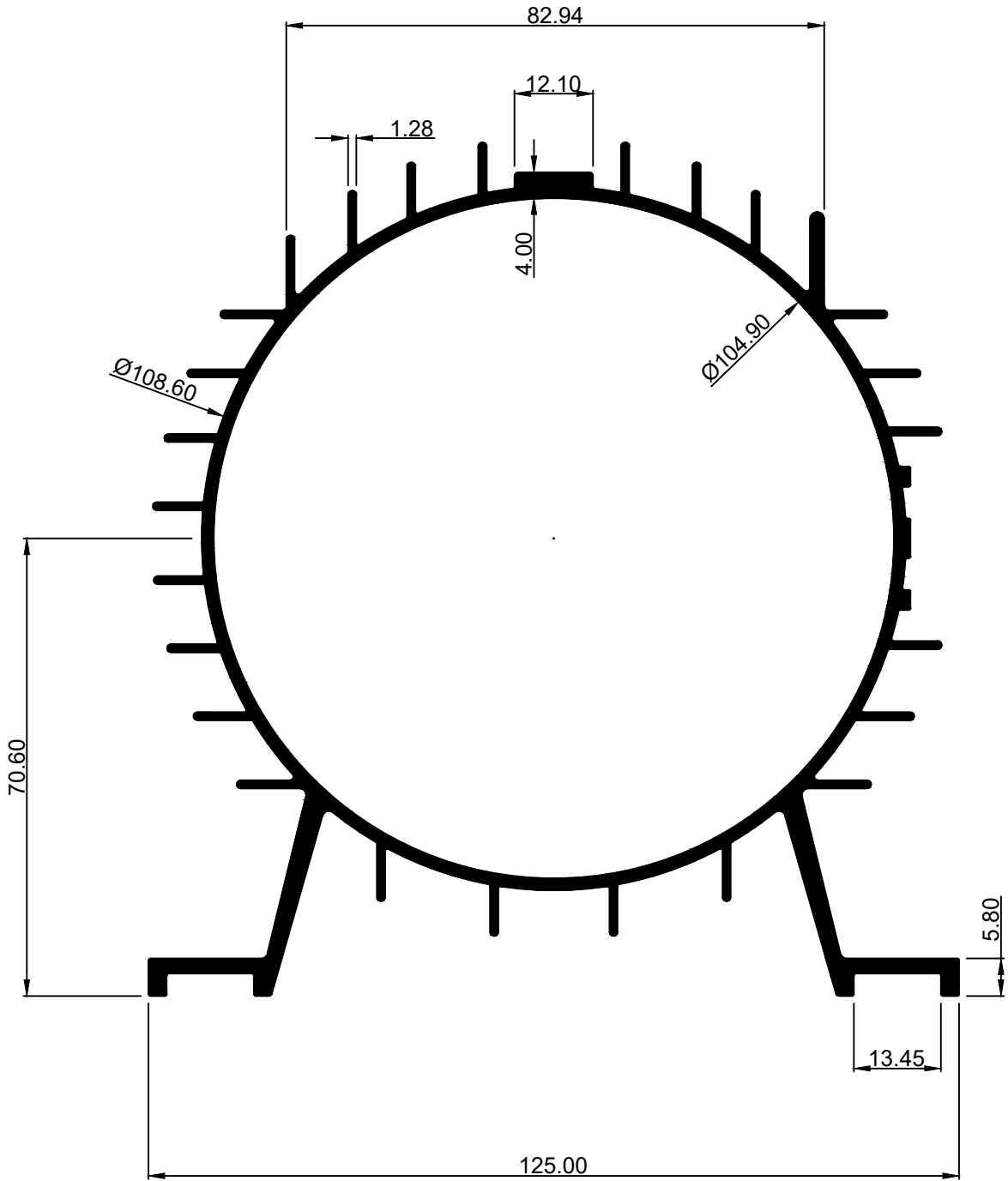

WEIGHT:- 12.300 kg/12'

SHREENATHJI EXTRUSION

SEC. NO:-30500

8246

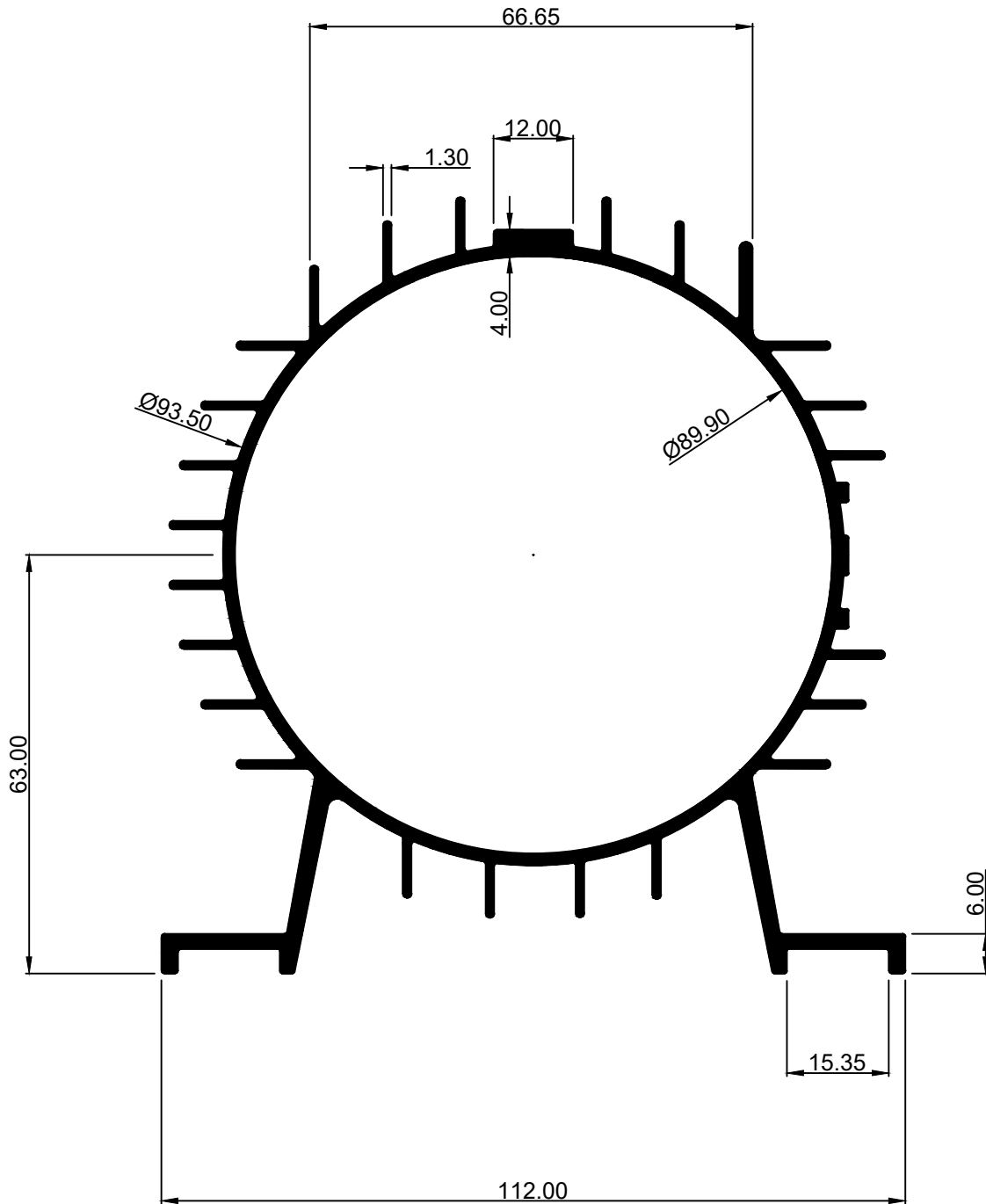

WEIGHT:- 10.964 kg/12'

SHREENATHJI EXTRUSION

SECTION No.:- SE-228

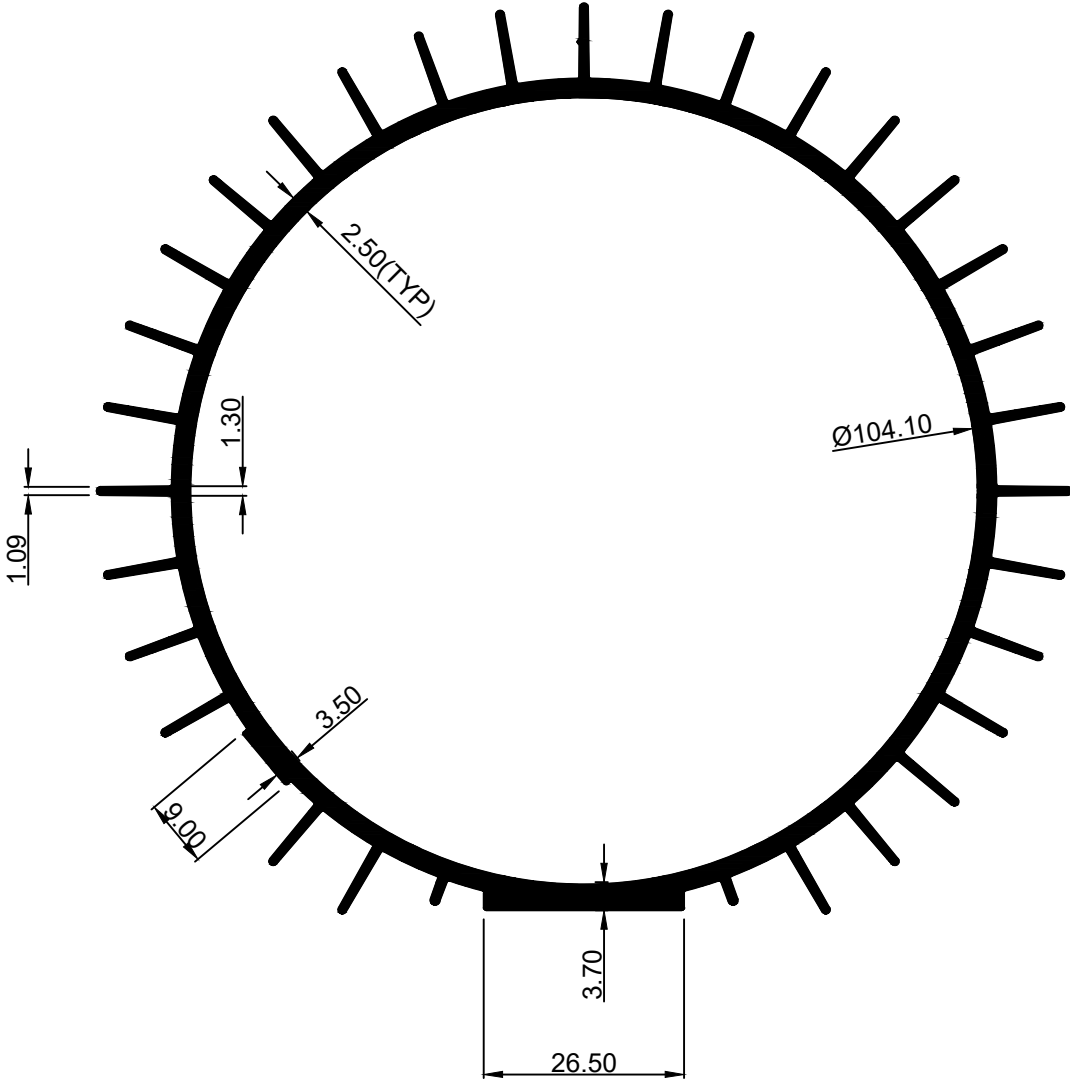

WEIGHT:- 3.357 Kg/Mtr.

# SHREENATHJI EXTRUSION

SECTION No.:- SE-230

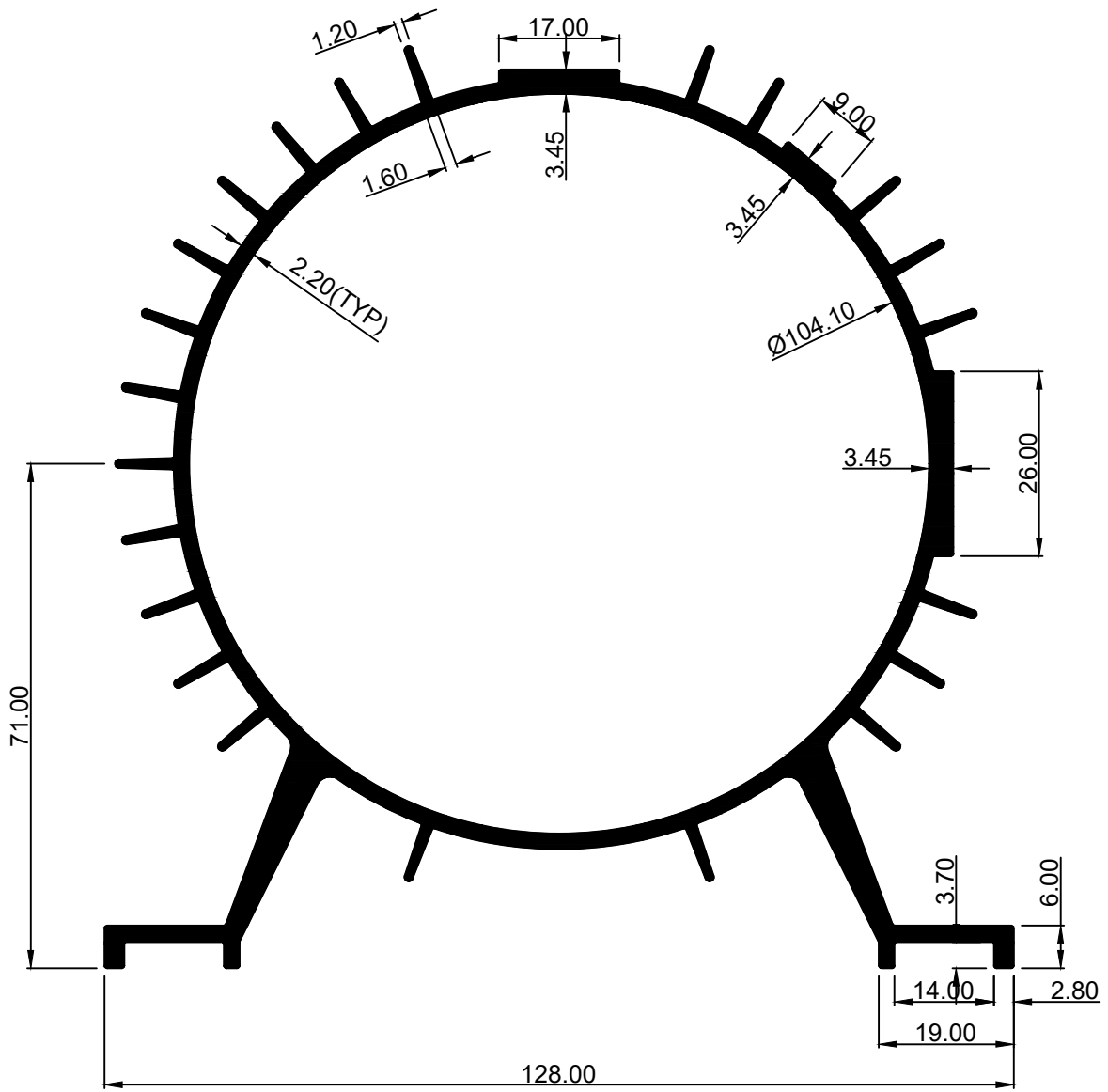

WEIGHT:- 3.827 Kg/Mtr.

SHREENATHJI EXTRUSION

SECTION No.:- SE-233

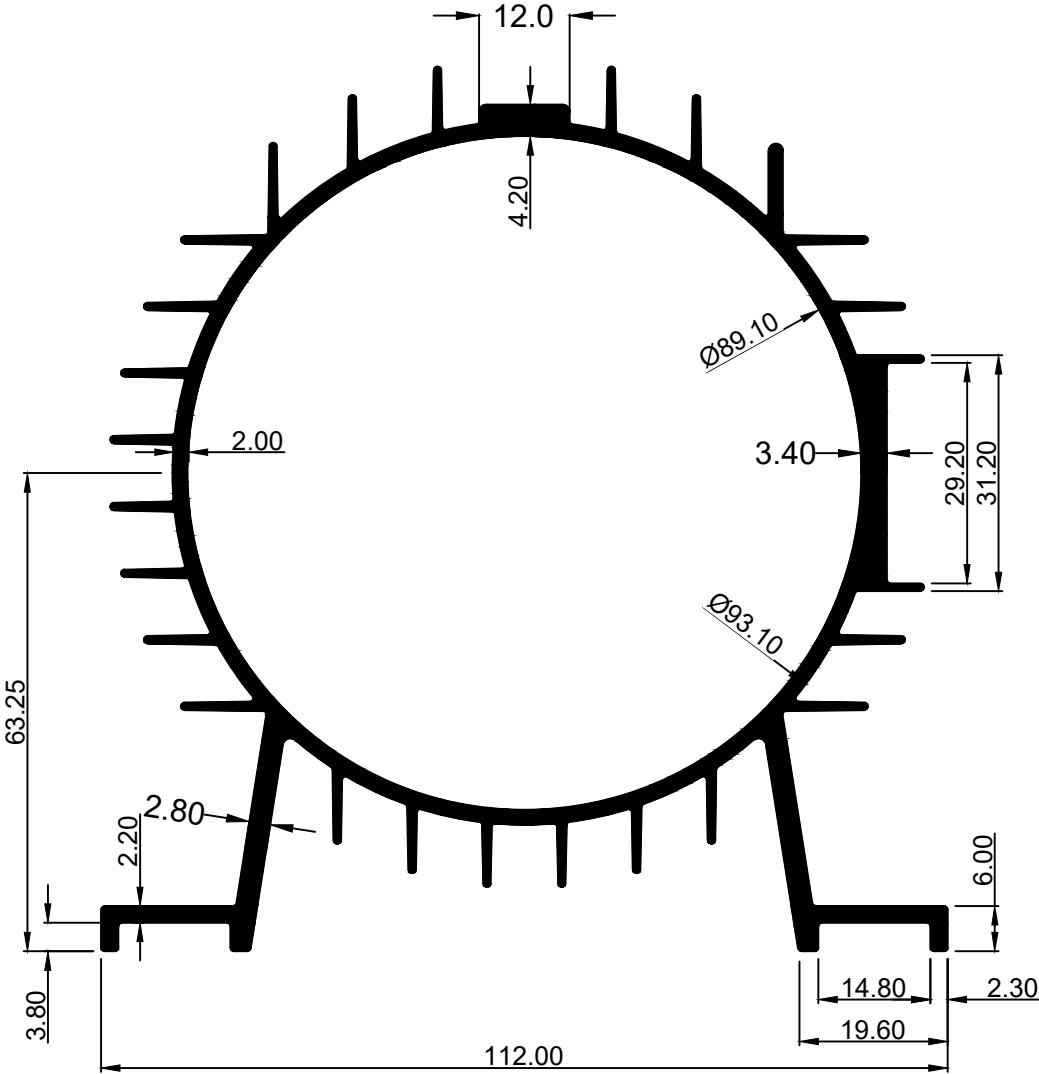

WEIGHT:- 12.045 Kg/12'

# SHREENATHJI EXTRUSION

SECTION No.:- SE-459

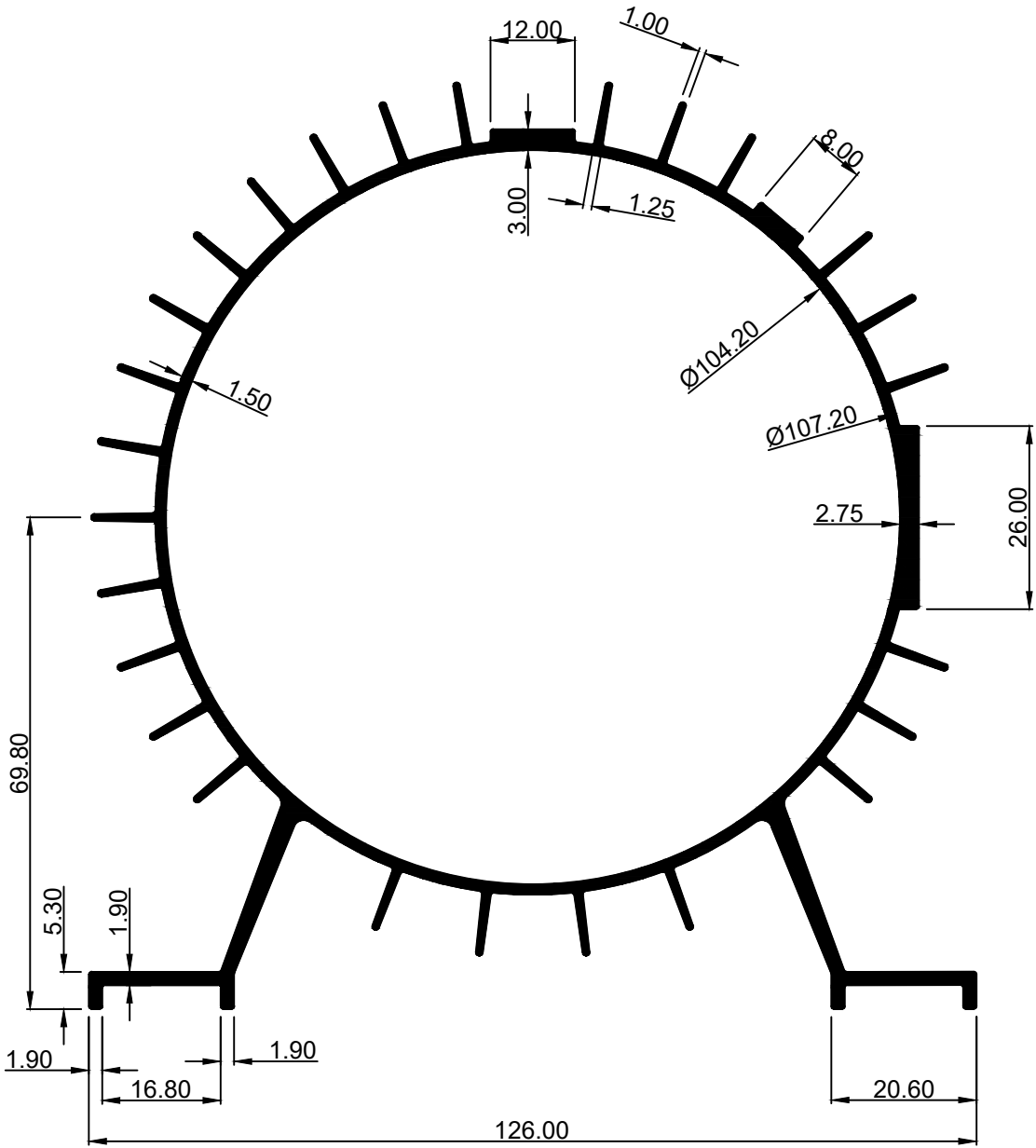

10.5158 Kg/12'

# SHREENATHJI EXTRUSION

SECTION No.: - SE-460

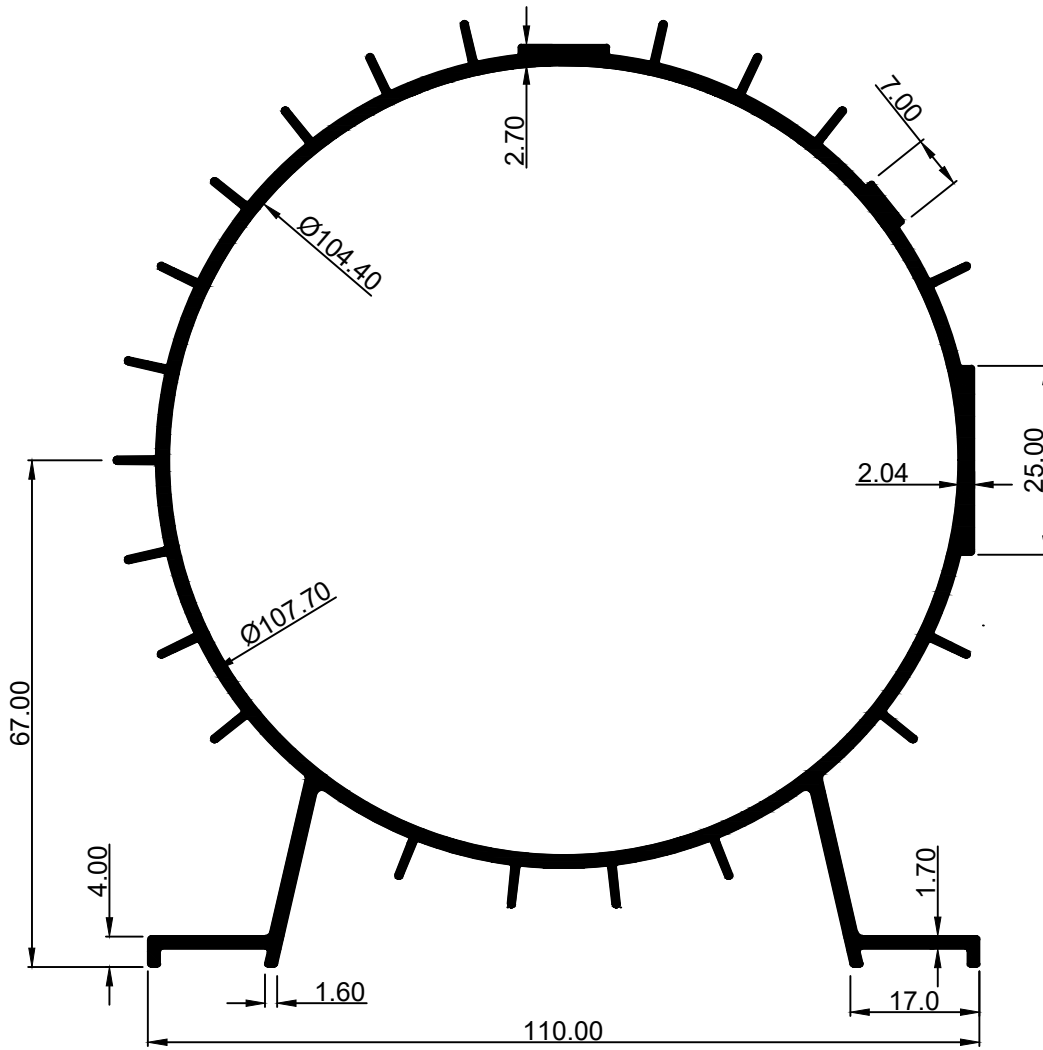

8.8547 Kg/12'

# SHREENATHJI EXTRUSION

SECTION No.:- SE-513

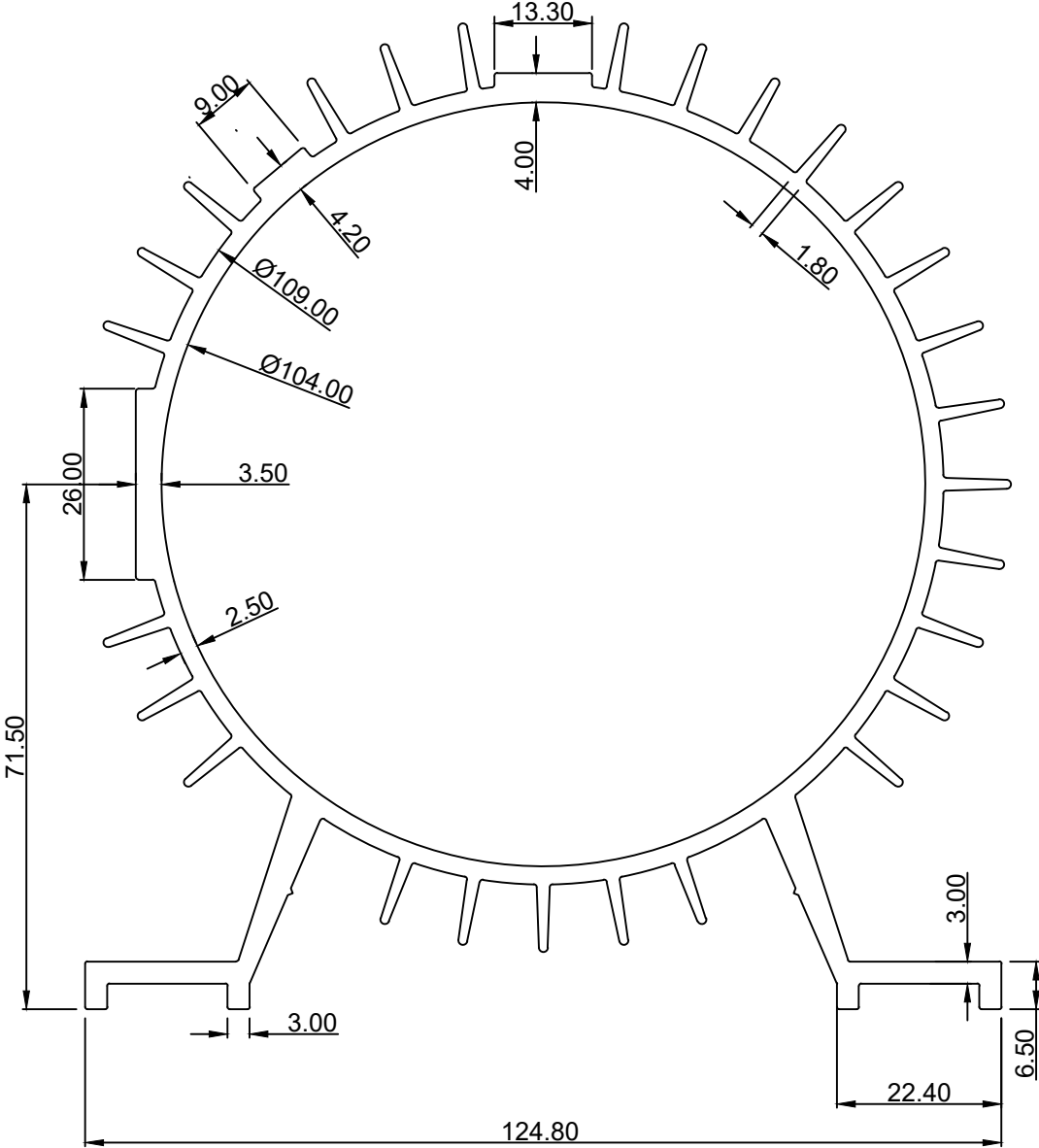

15.9656 Kg/12'



# SHREENATHJI EXTRUSION

SECTION No.: -SE-595

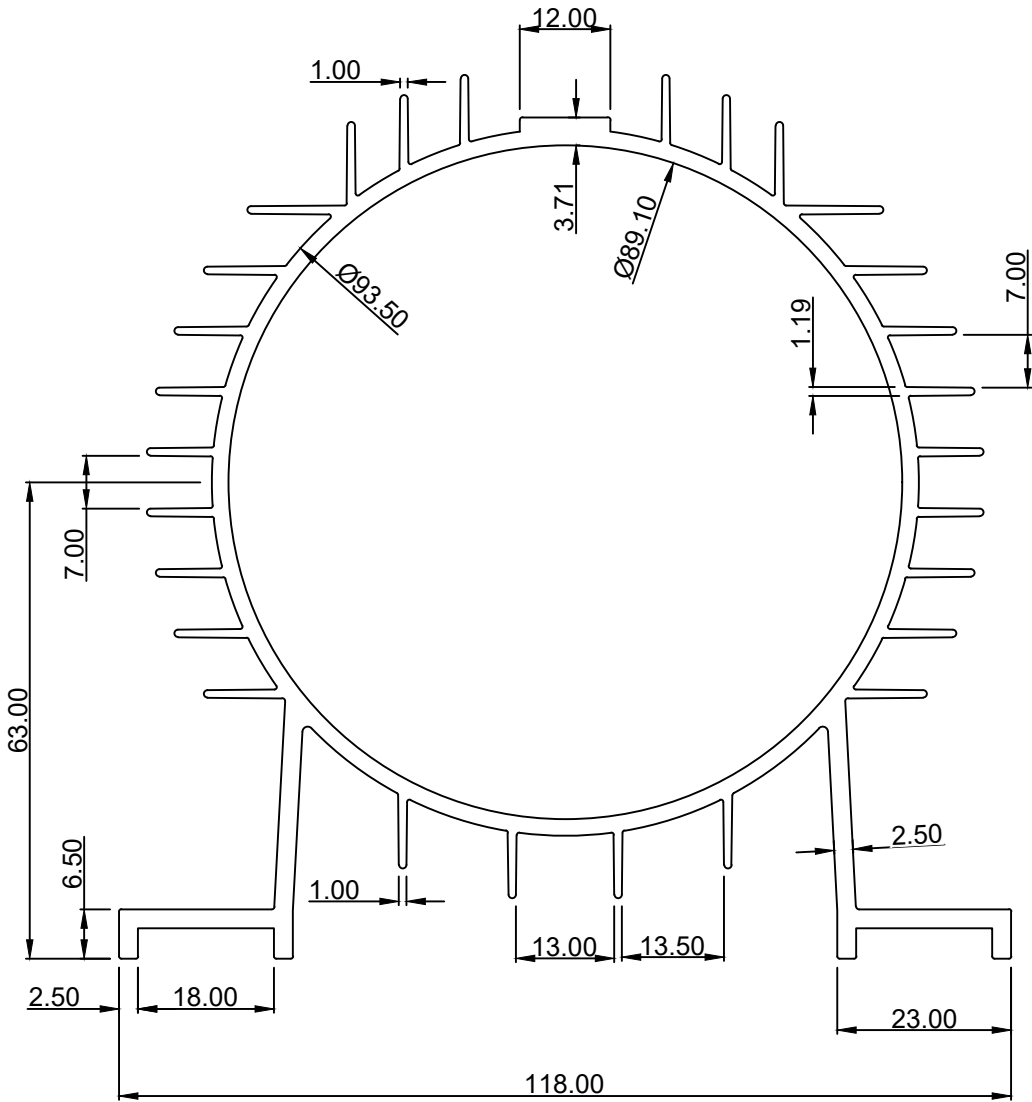

12.186 Kg/12'

SHREENATHJI EXTRUSION

SECTION No.:- SE-1132

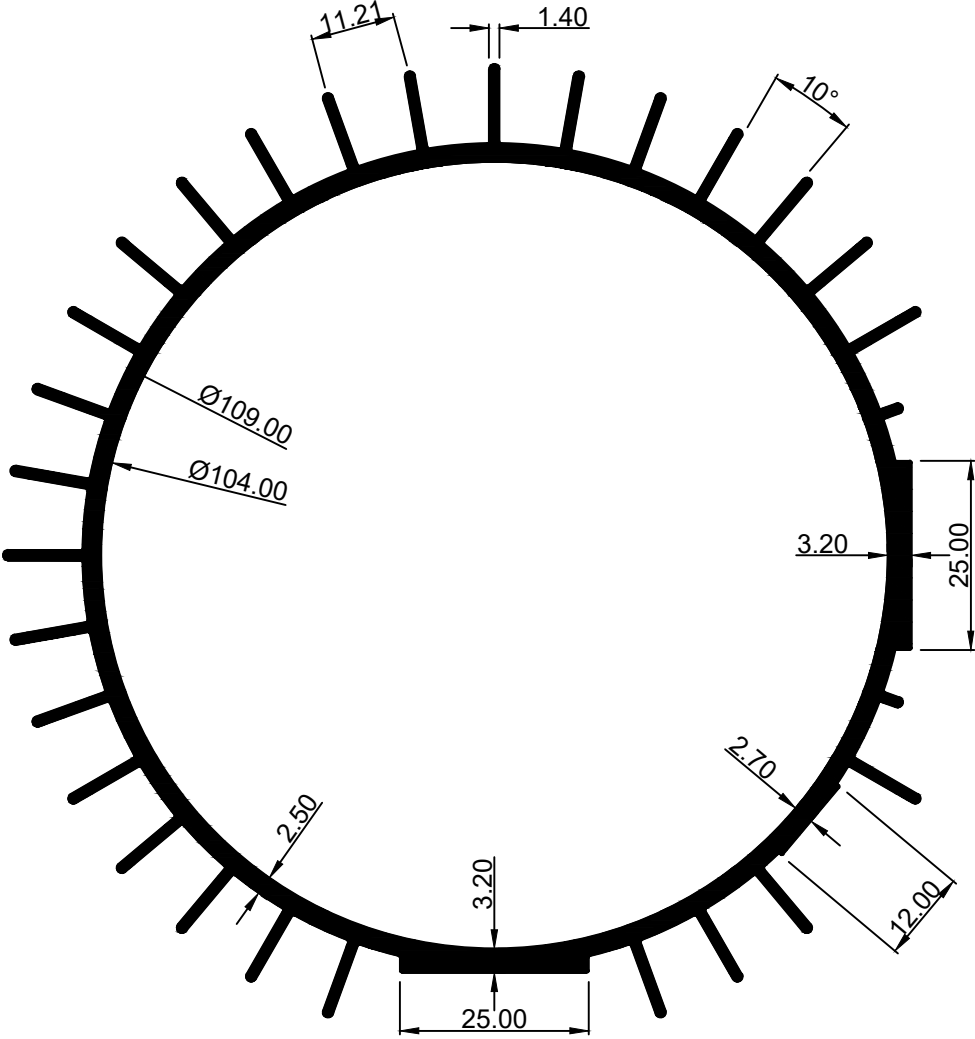

12.8421 Kg/12'

# SHREENATHJI EXTRUSION

SECTION No.:- SE-1251

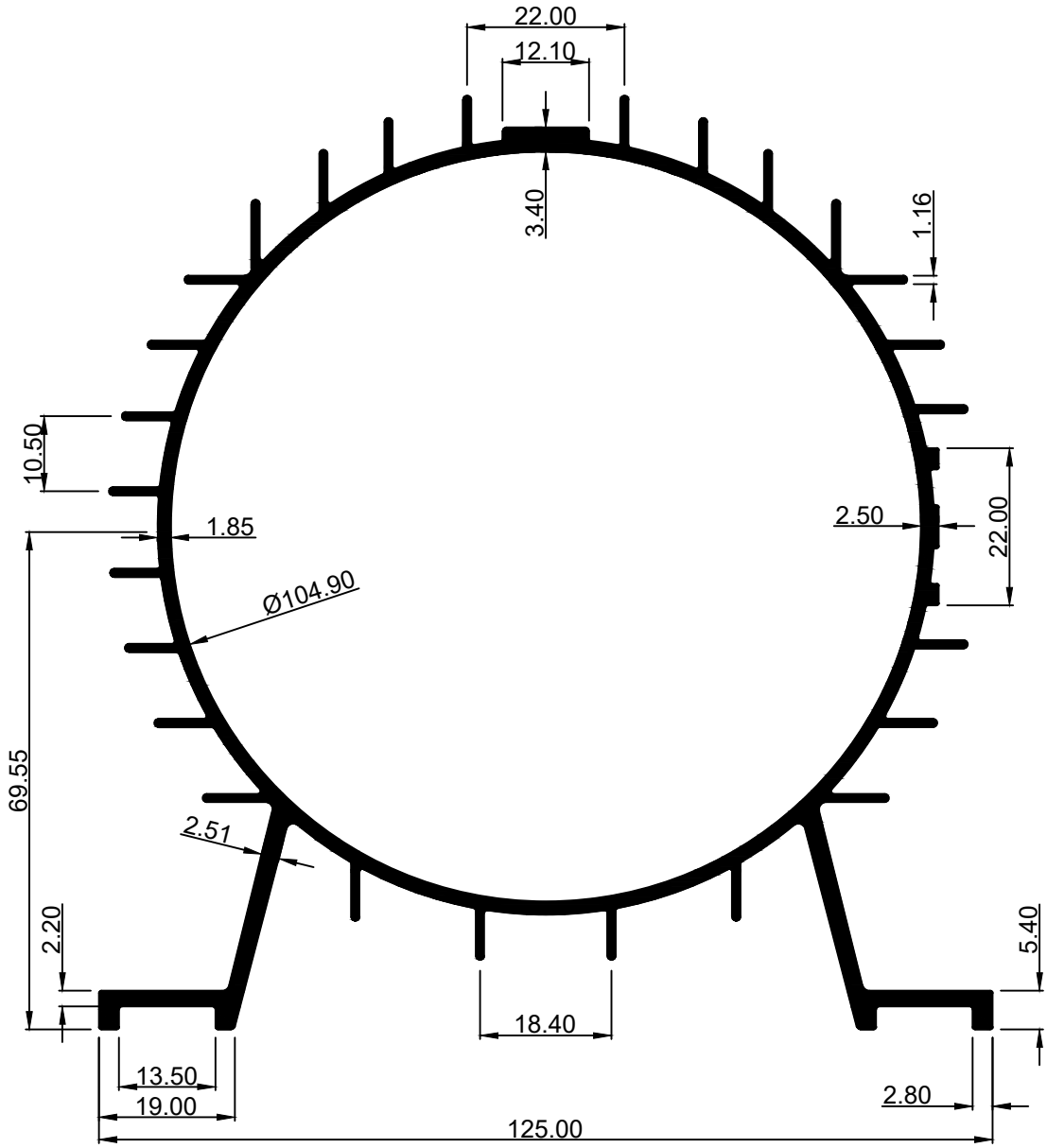

3.0815 Kg/Mtr.

# SHREENATHJI EXTRUSION

SECTION No.:- SE-1271

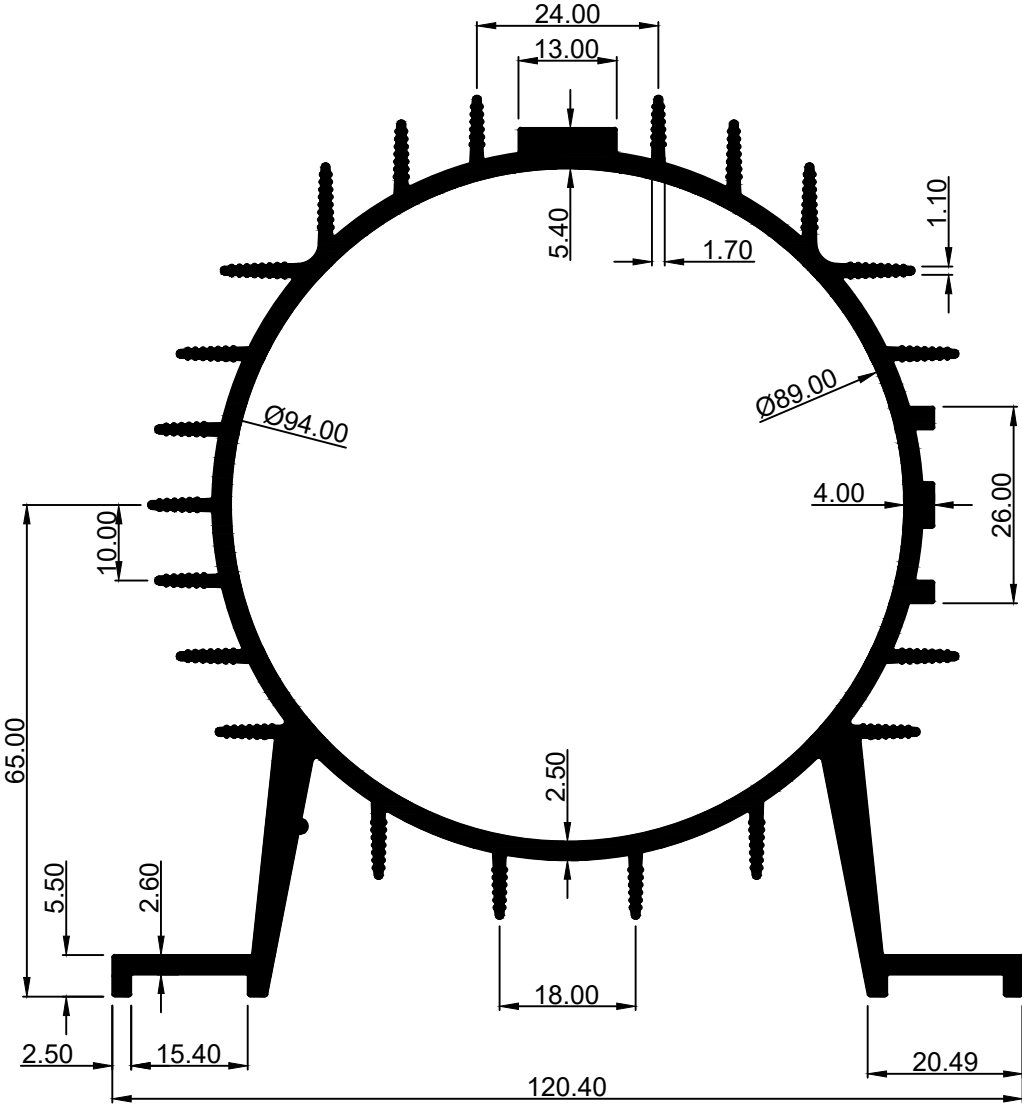

14.6158 Kg/12"

# SHREENATHJI EXTRUSION

SECTION No.:- SE-1272

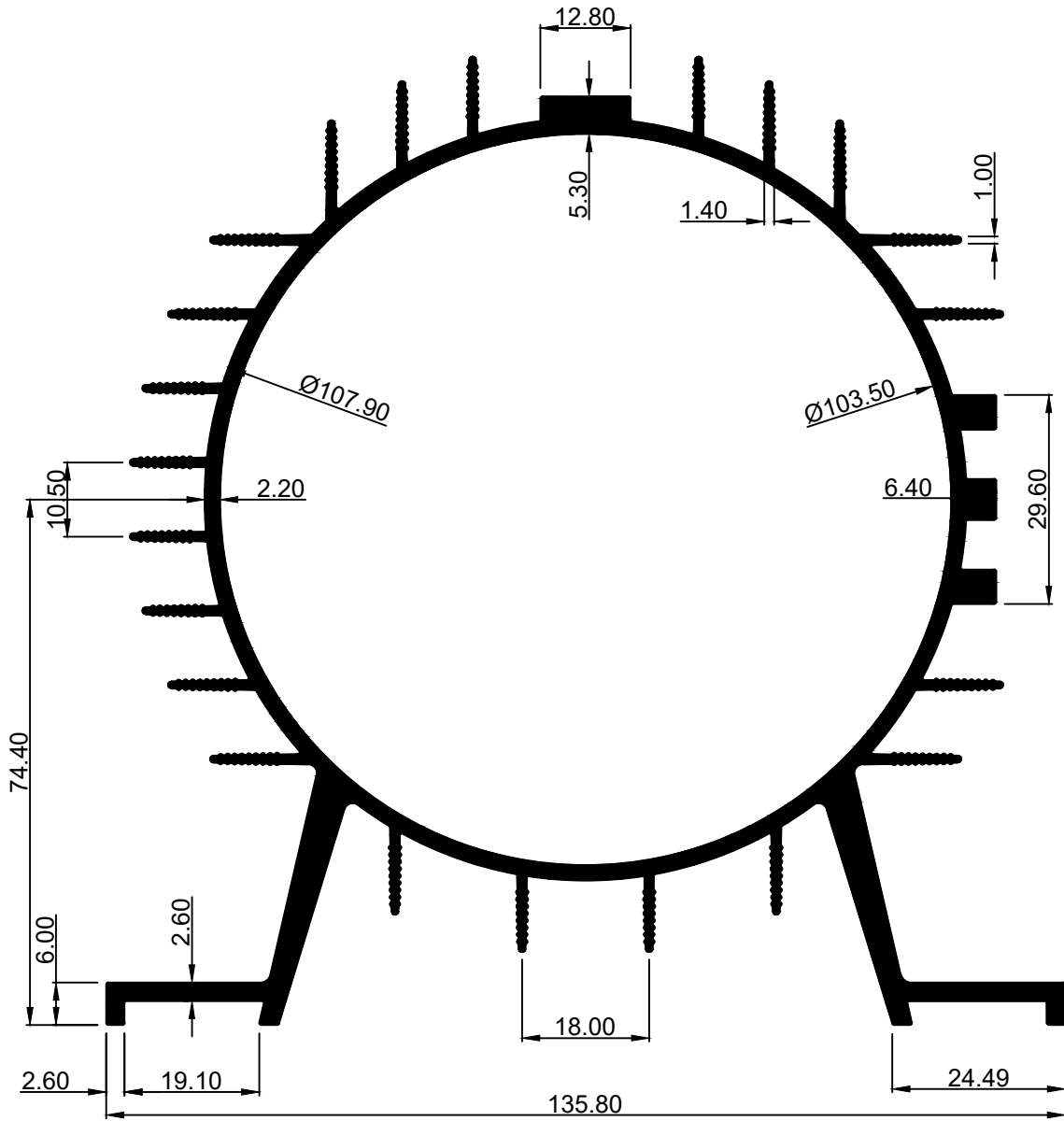

16.0325 Kg/12"

SHREENATHJI EXTRUSION

SECTION NO:- SE-1503

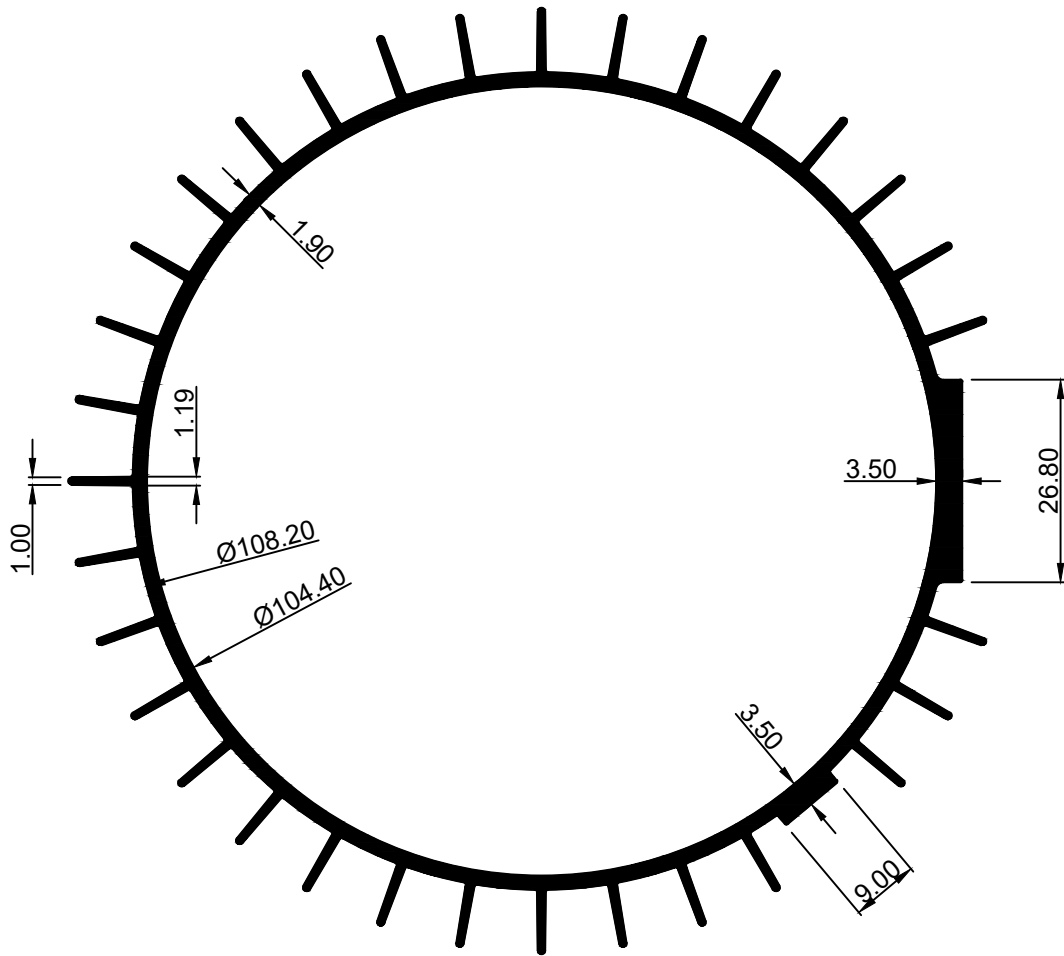

WEIGHT:- 9.9102 Kg/12'

SHREENATHJI EXTRUSION

SECTION NO:- SE-1504

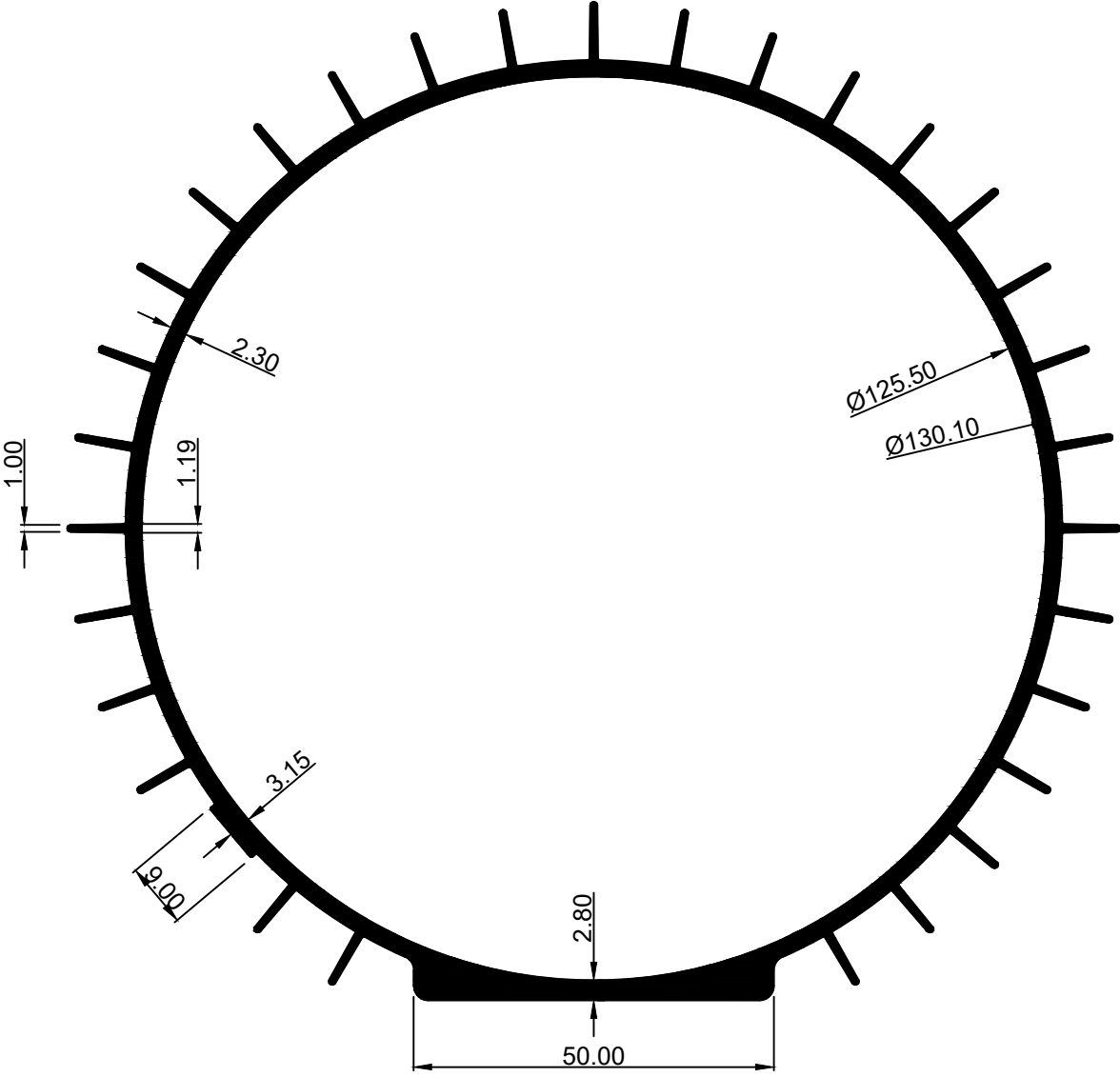

WEIGHT:- 12.8573 Kg/12'