

SHREENATHJI EXTRUSION

SEC. NO:-30526

BLF-365

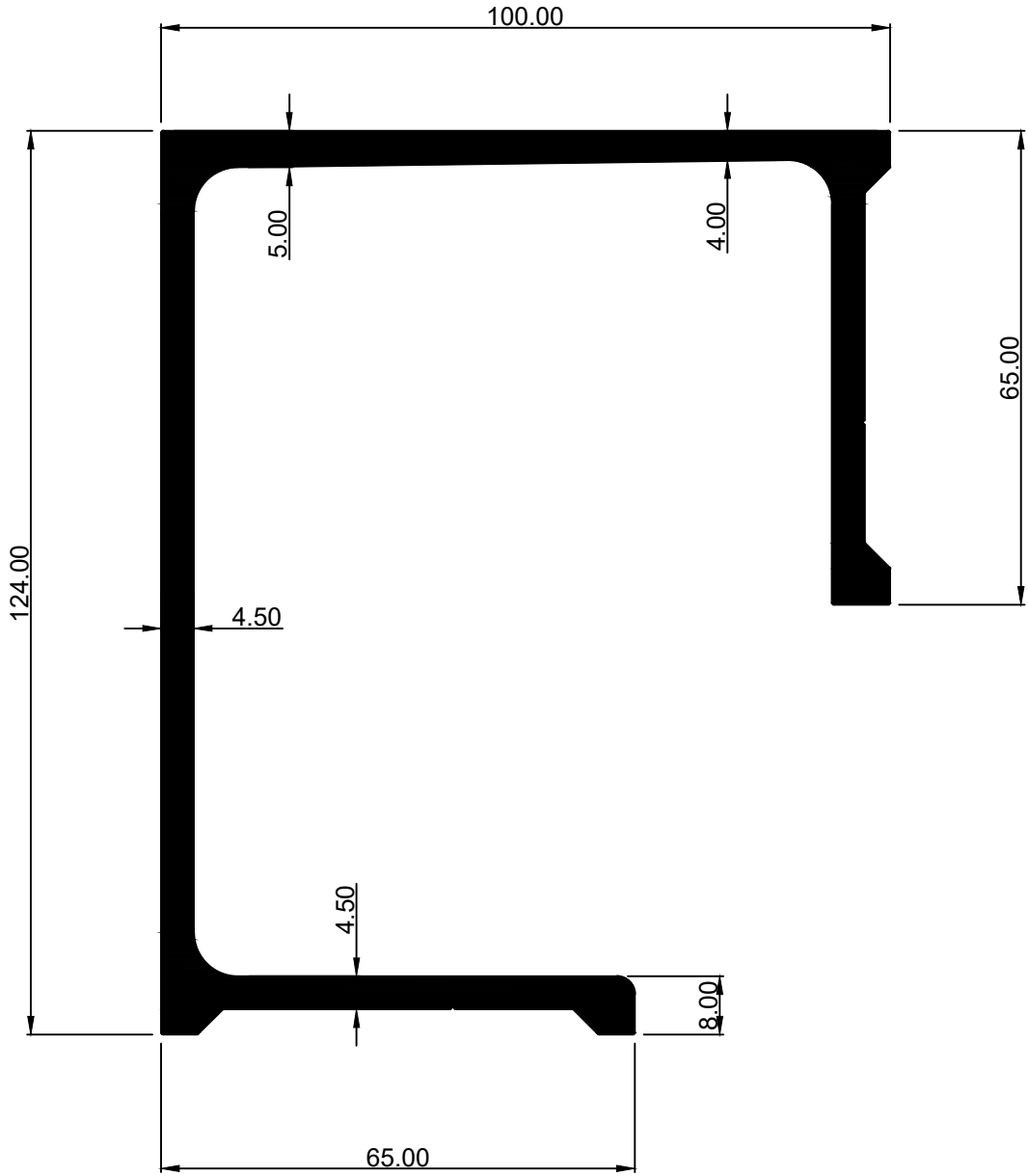

WEIGHT:- 15.975 kg/12'

SHREENATHJI EXTRUSION

SEC. NO:-30527

BLF-364

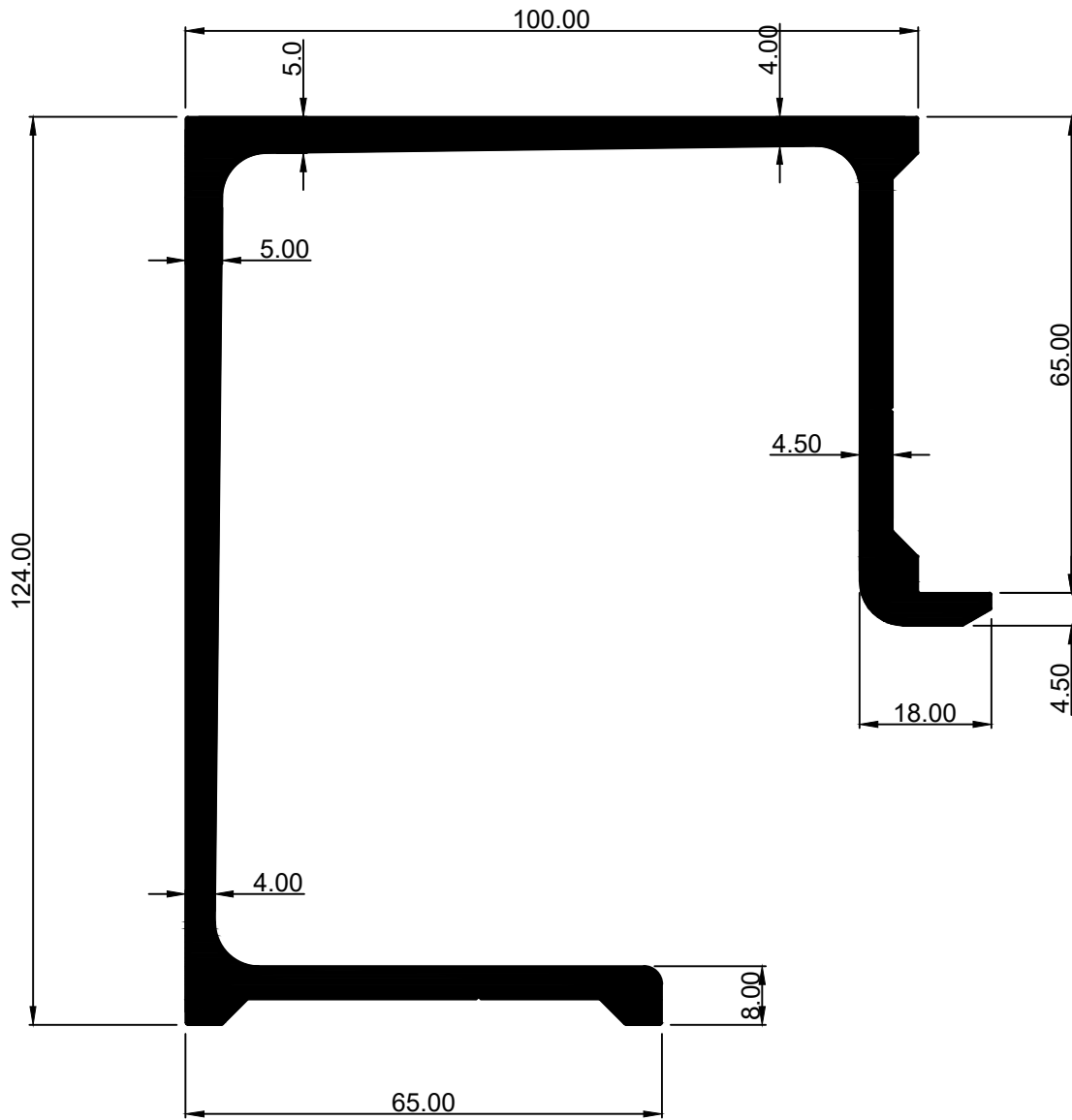

WEIGHT:- 16.656 kg/12'

SHREENATHJI EXTRUSION

SEC. NO:-30528

BLF-374

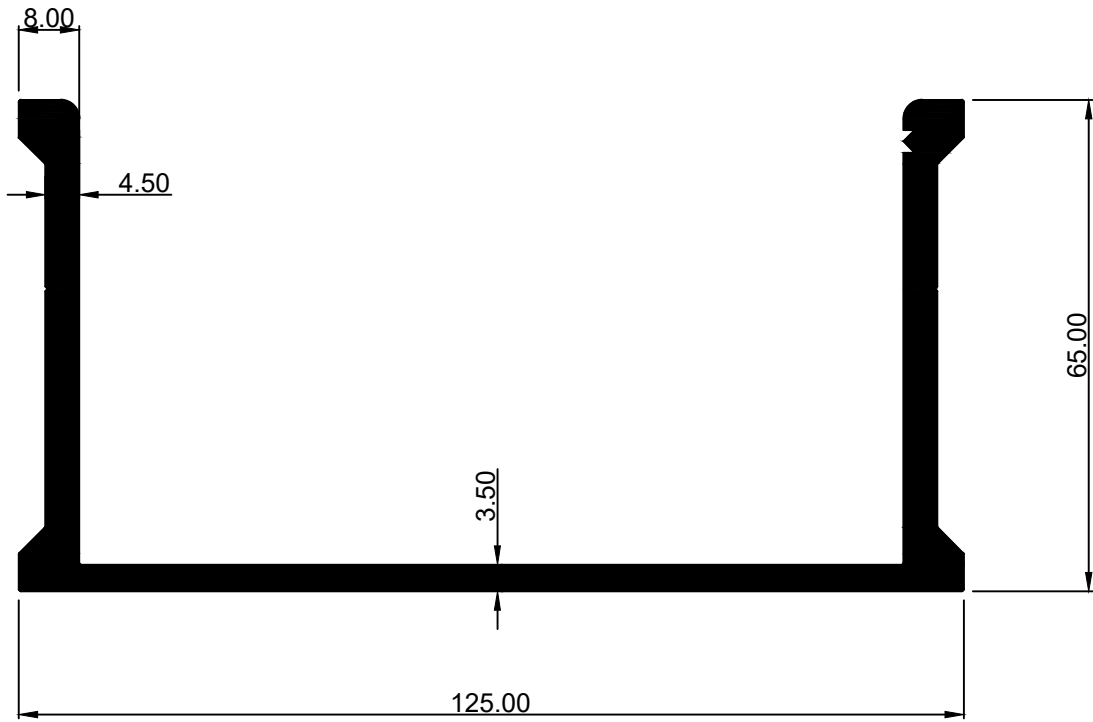

WEIGHT:- 10.431 kg/12'

SECTION No.:-SE-626 (BLF-533)

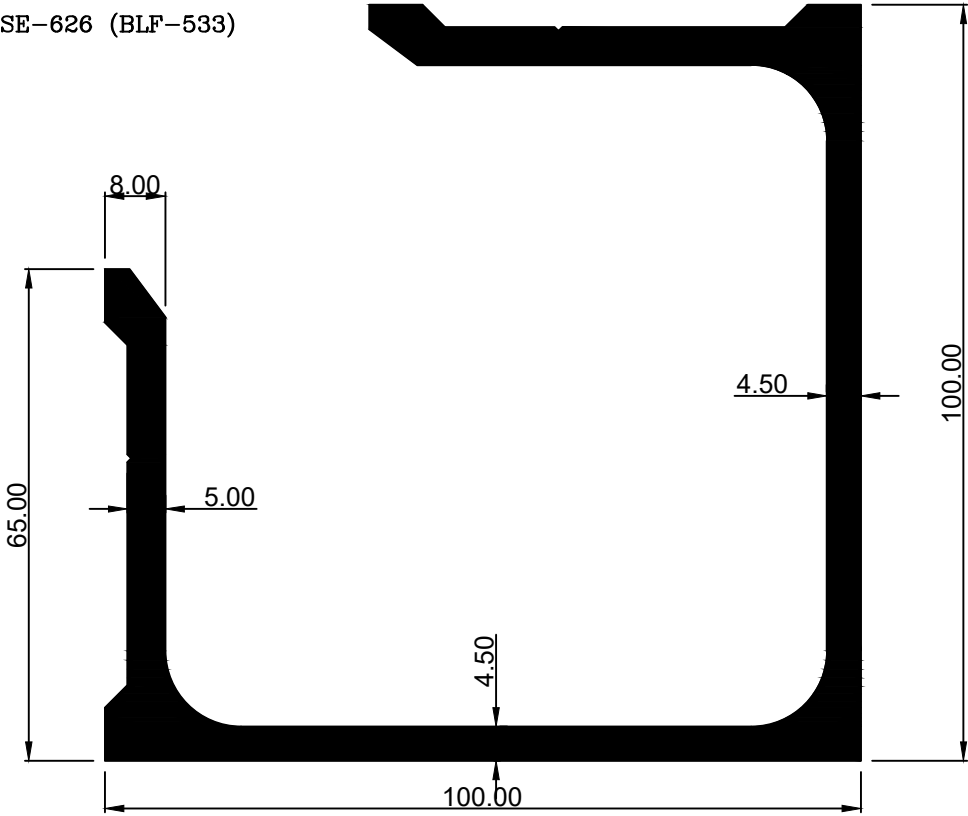

4.303 Kg/Mtr.

SHREENATHJI EXTRUSION

SEC. NO:-30530

BLF-21

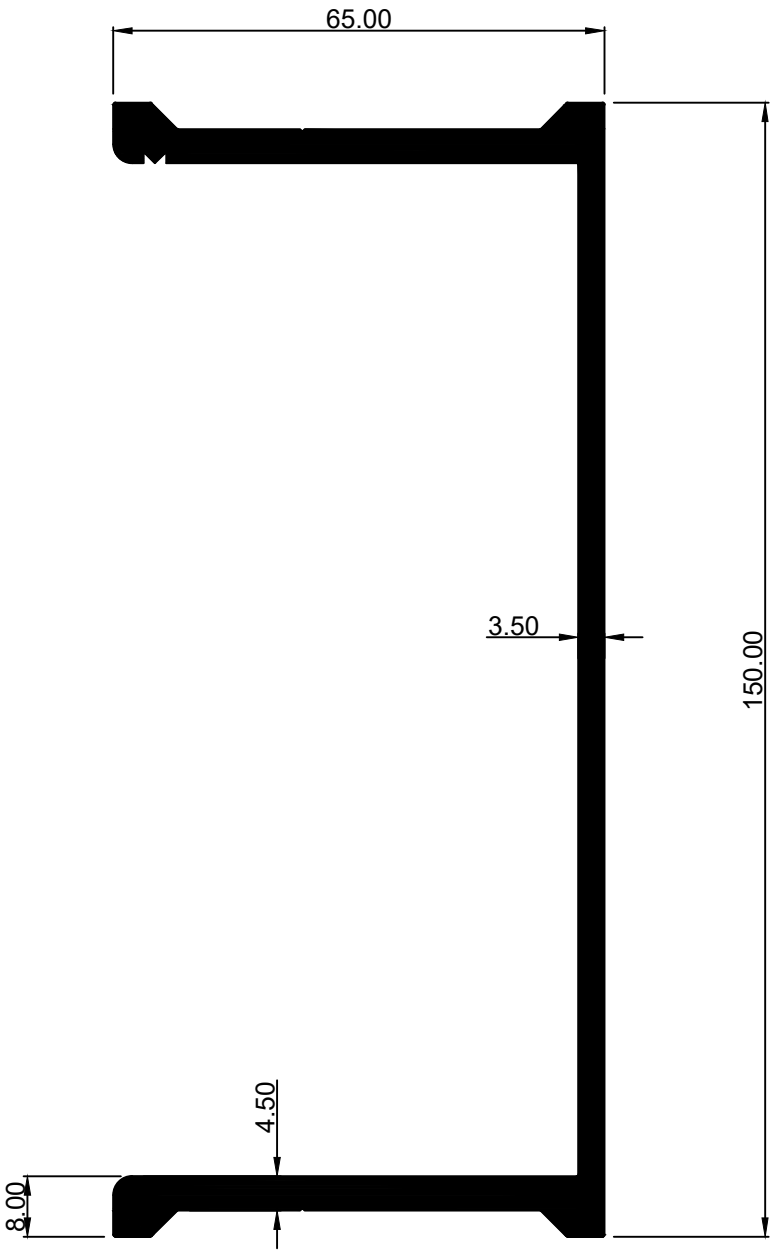

WEIGHT:- 11.300 kg/12'

SHREENATHJI EXTRUSION

SECTION No.:—SE-627 (BLF-261)

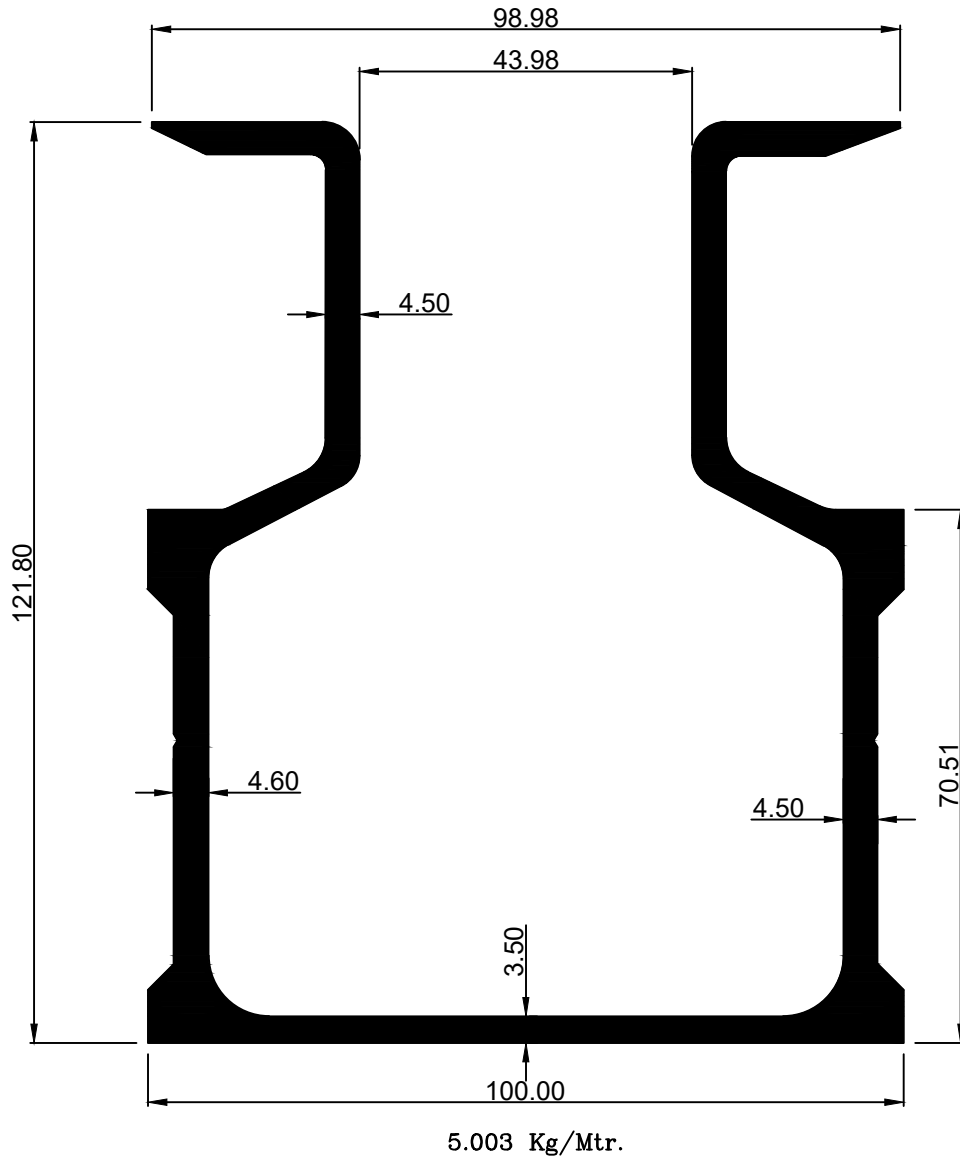

SECTION No.:—SE-628 (9315 FLAT RAIL)

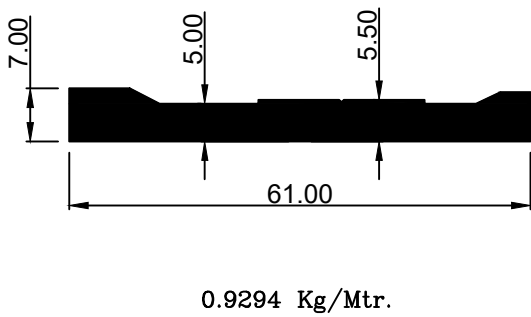

SECTION No.:—SE-630 (9314 SIDE RAIL)

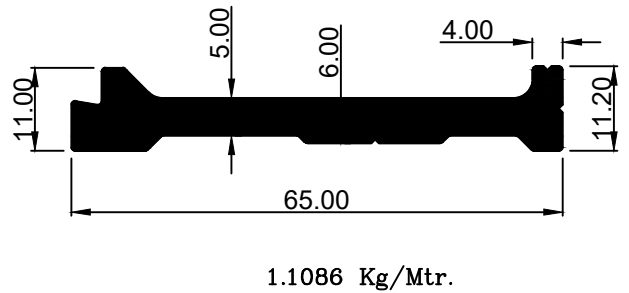

SHREENATHJI EXTRUSION

SECTION No.:--SE-631 (9316 STIFNER)

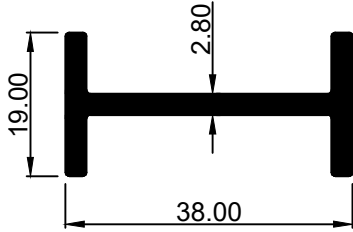

0.5316 Kg/Mtr.

SECTION No.:--SE-838

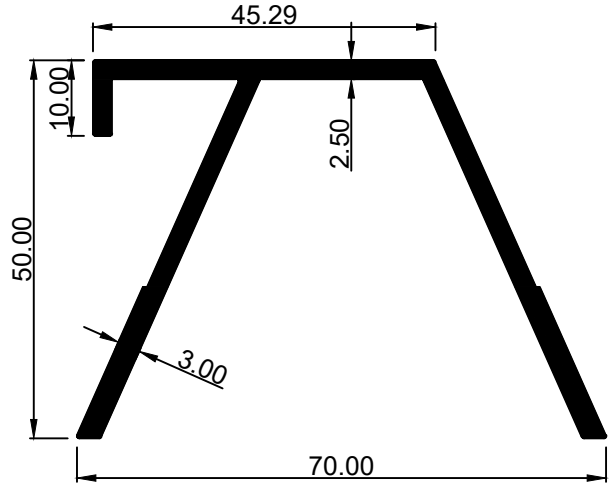

1.1203 Kg/Mtr.

SECTION No.:--SE-839

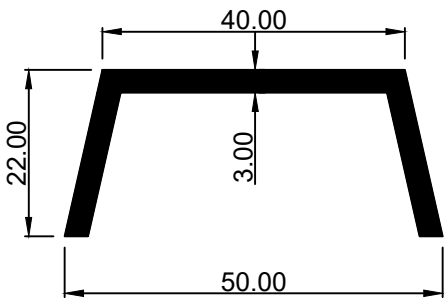

0.6451 Kg/Mtr.

SECTION No.:--SE-840

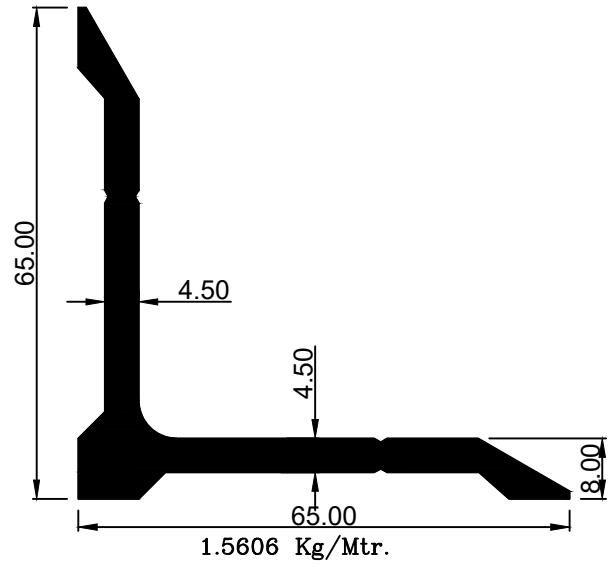

1.5806 Kg/Mtr.

SECTION No.:--SE-841

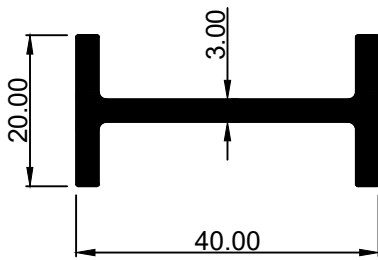

0.6013 Kg/Mtr.

SHREENATHJI EXTRUSION

SECTION No.:—SE—802

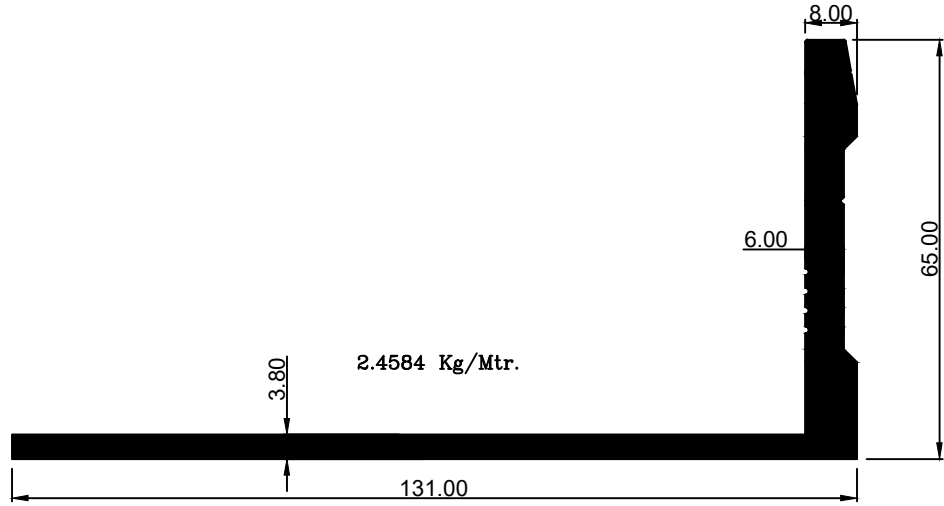

SECTION No.:—SE—803

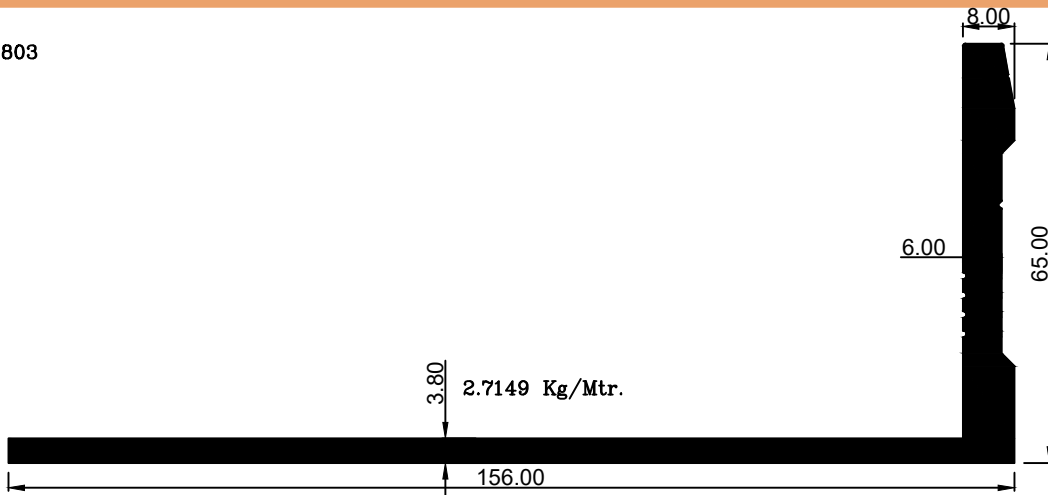

SECTION No.:—SE—804

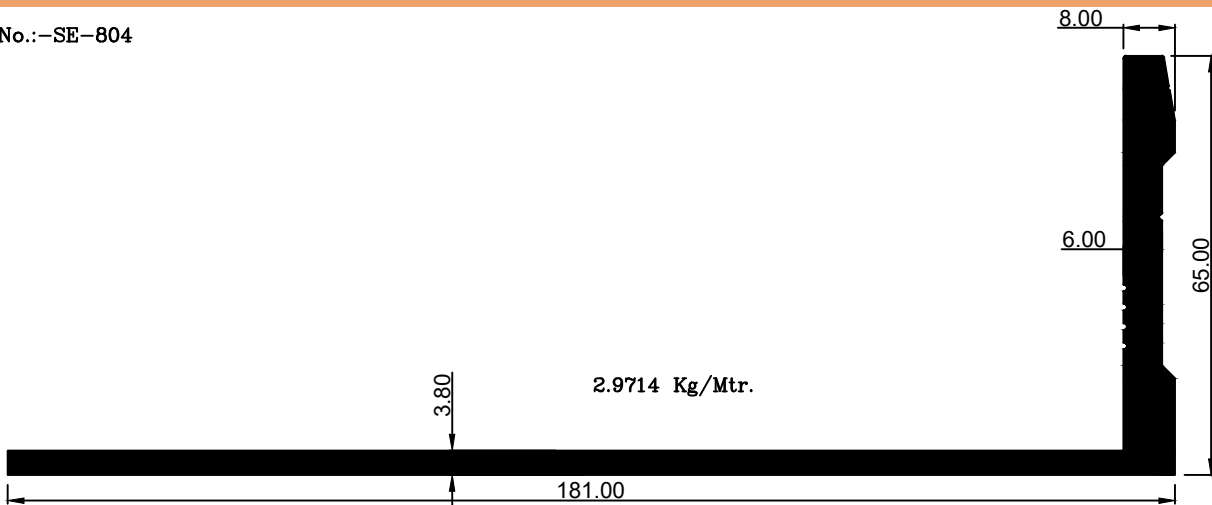

SHREENATHJI EXTRUSION

SECTION No.:--SE-805

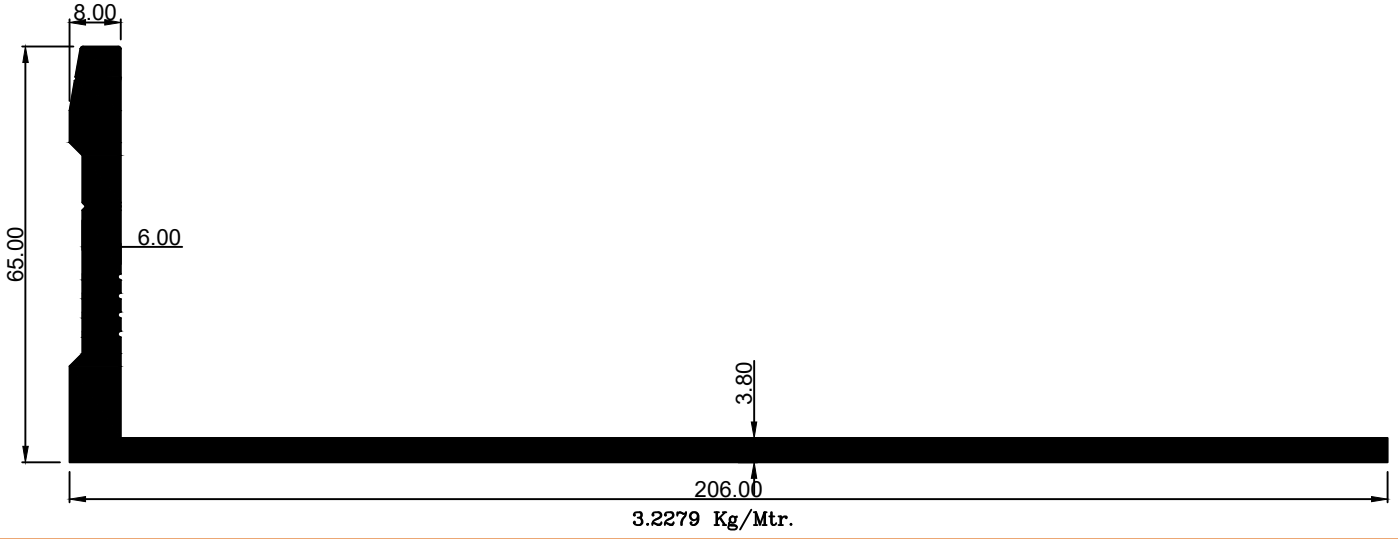

SECTION No.:--SE-842

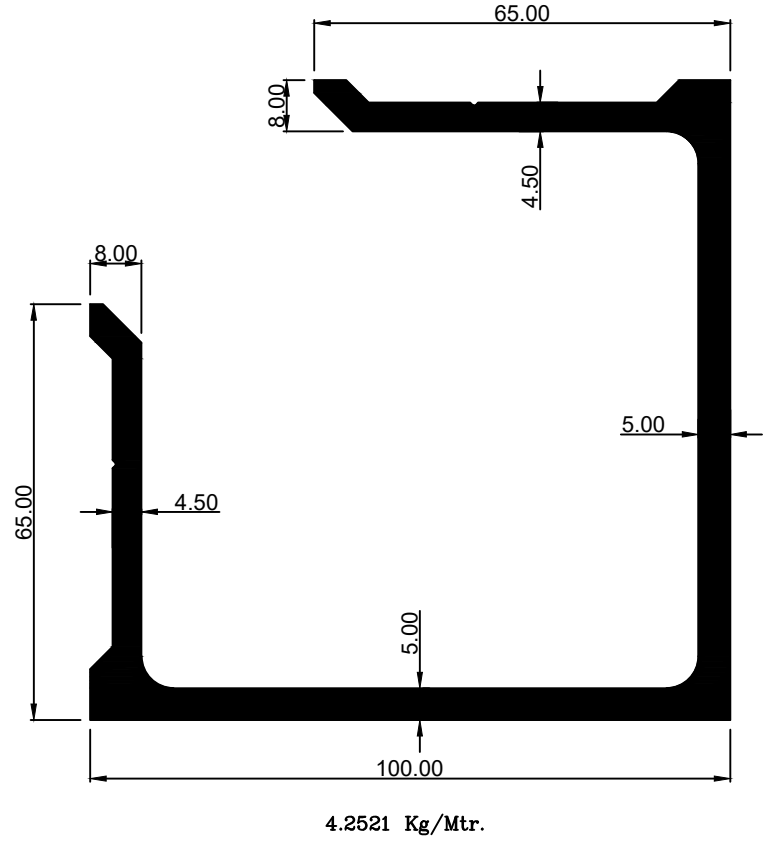

SHREENATHJI EXTRUSION

SECTION No.:—SE—843

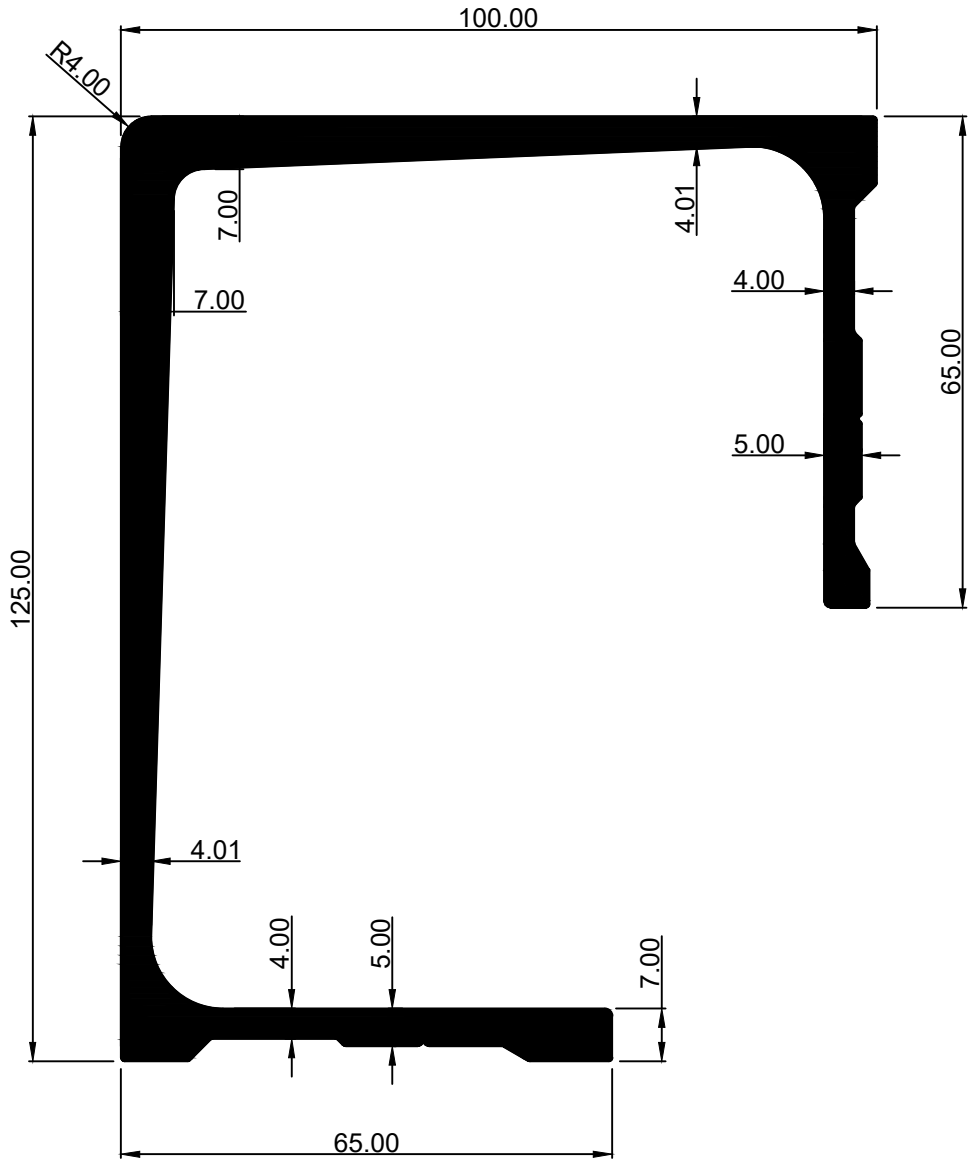

4.9536 Kg/Mtr.

SHREENATHJI EXTRUSION

SECTION No.:—SE-844

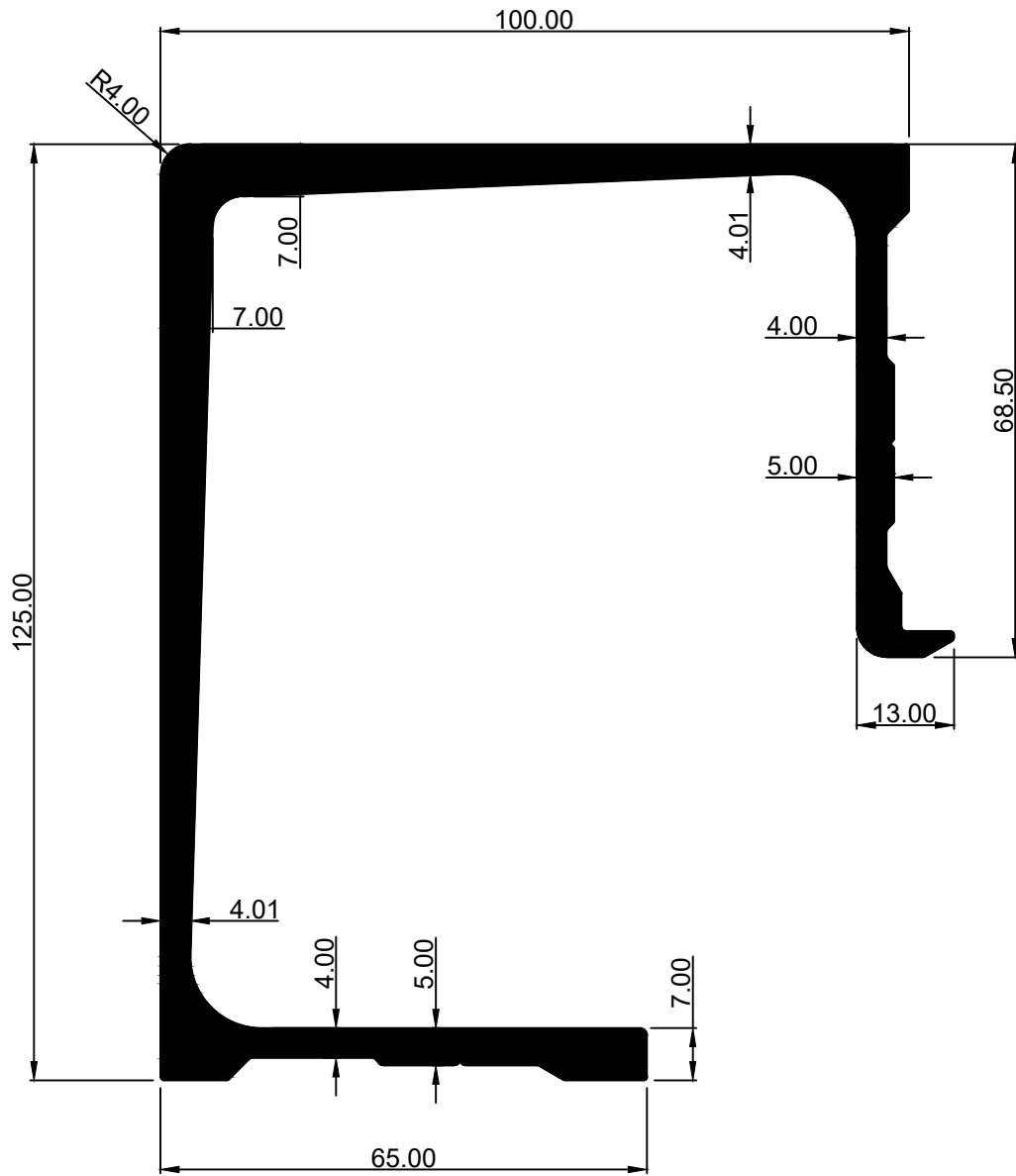

5.0554 Kg/Mtr.

SHREENATHJI EXTRUSION

SECTION No.:—SE—899

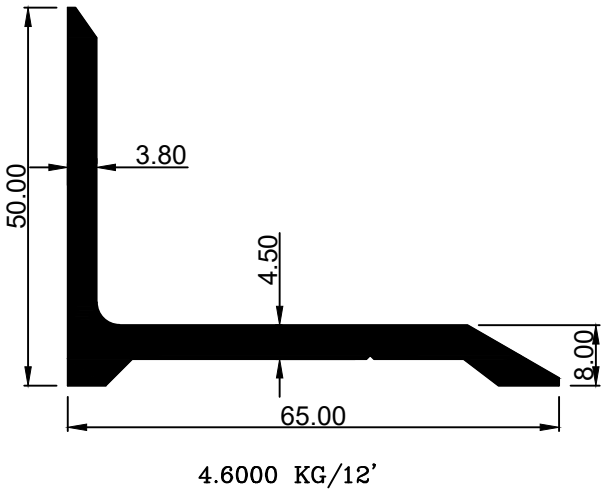

SECTION No.:—SE—901

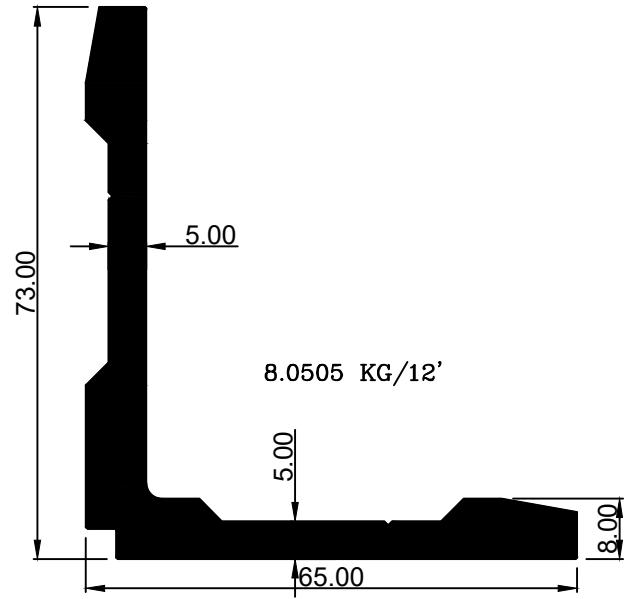

SECTION No.:—SE—902

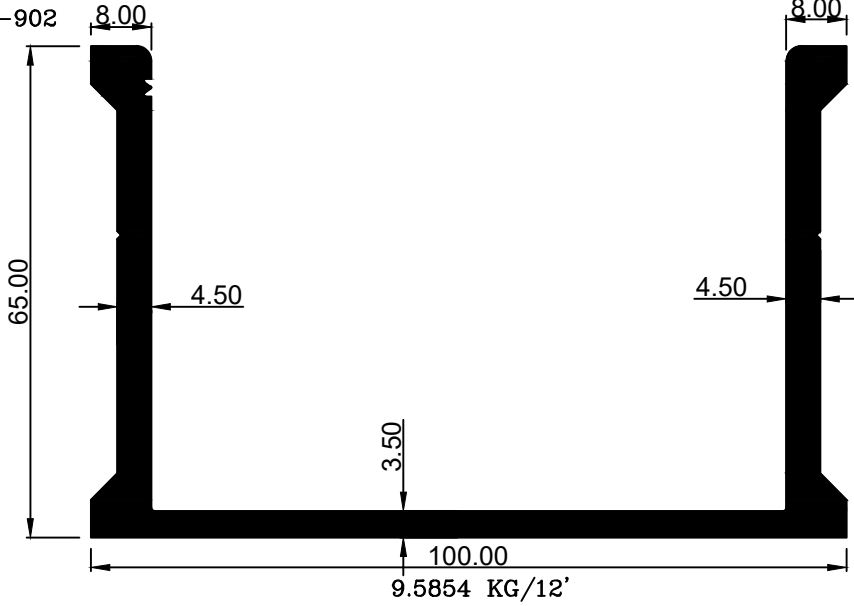

SECTION No.:—SE—903

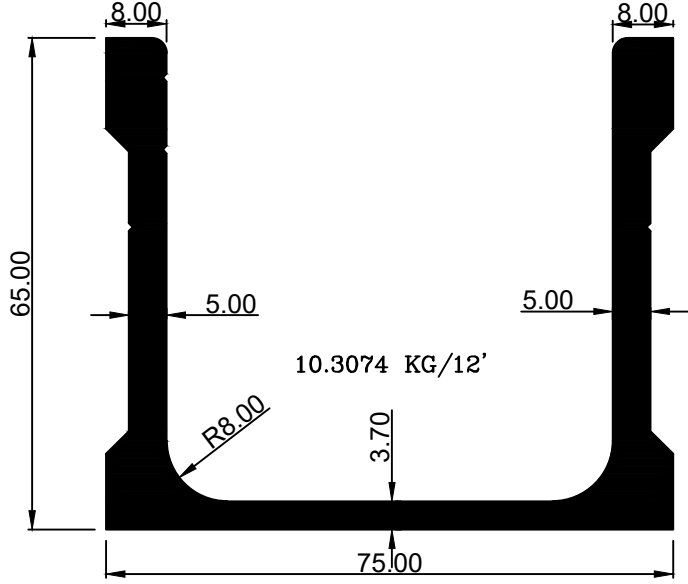

SHREENATHJI EXTRUSION

SECTION No.: -SE-1001

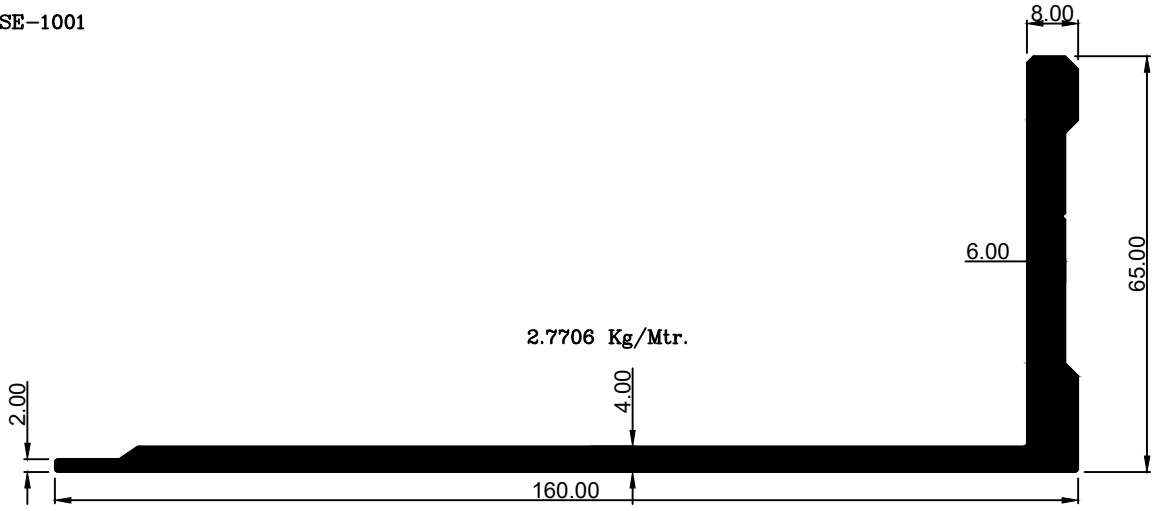

SECTION No.: -SE-1002

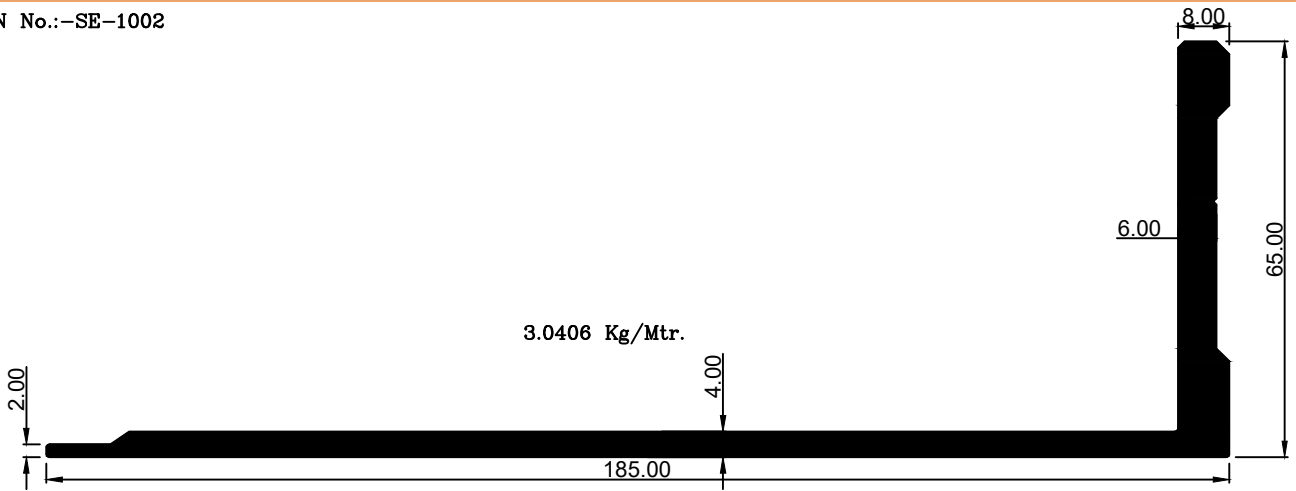

SECTION No.: -SE-1003

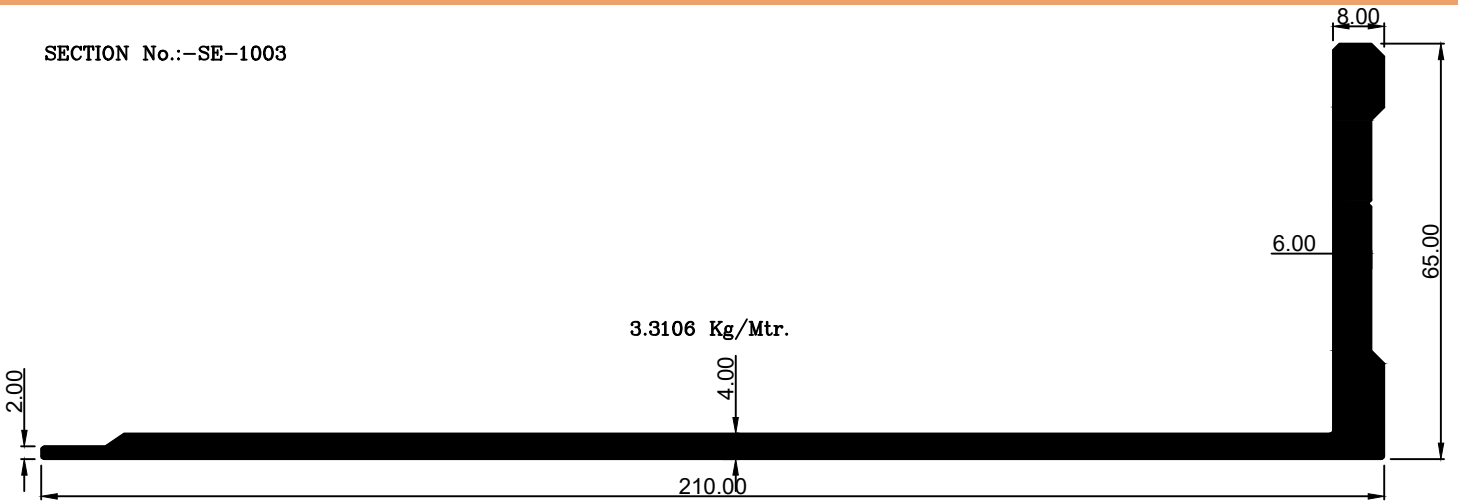

SHREENATHJI EXTRUSION

SECTION No.:- SE-1004

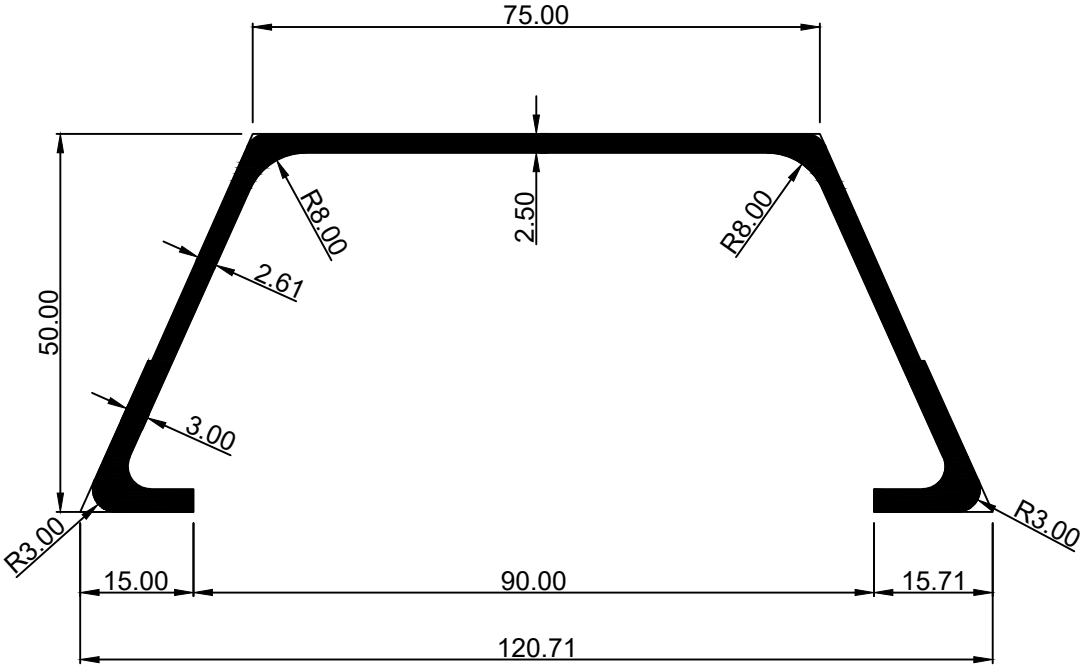

5.4865 Kg/12'

SECTION No.:- SE-1005

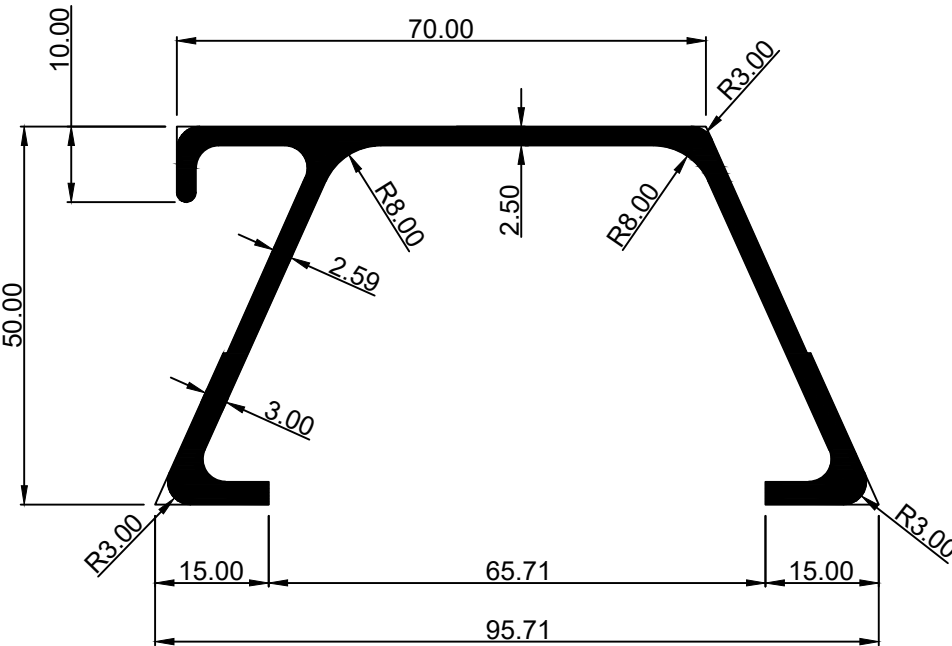

5.5620 Kg/12'

SHREENATHJI EXTRUSION

SECTION No.:—SE—1027 (1100)

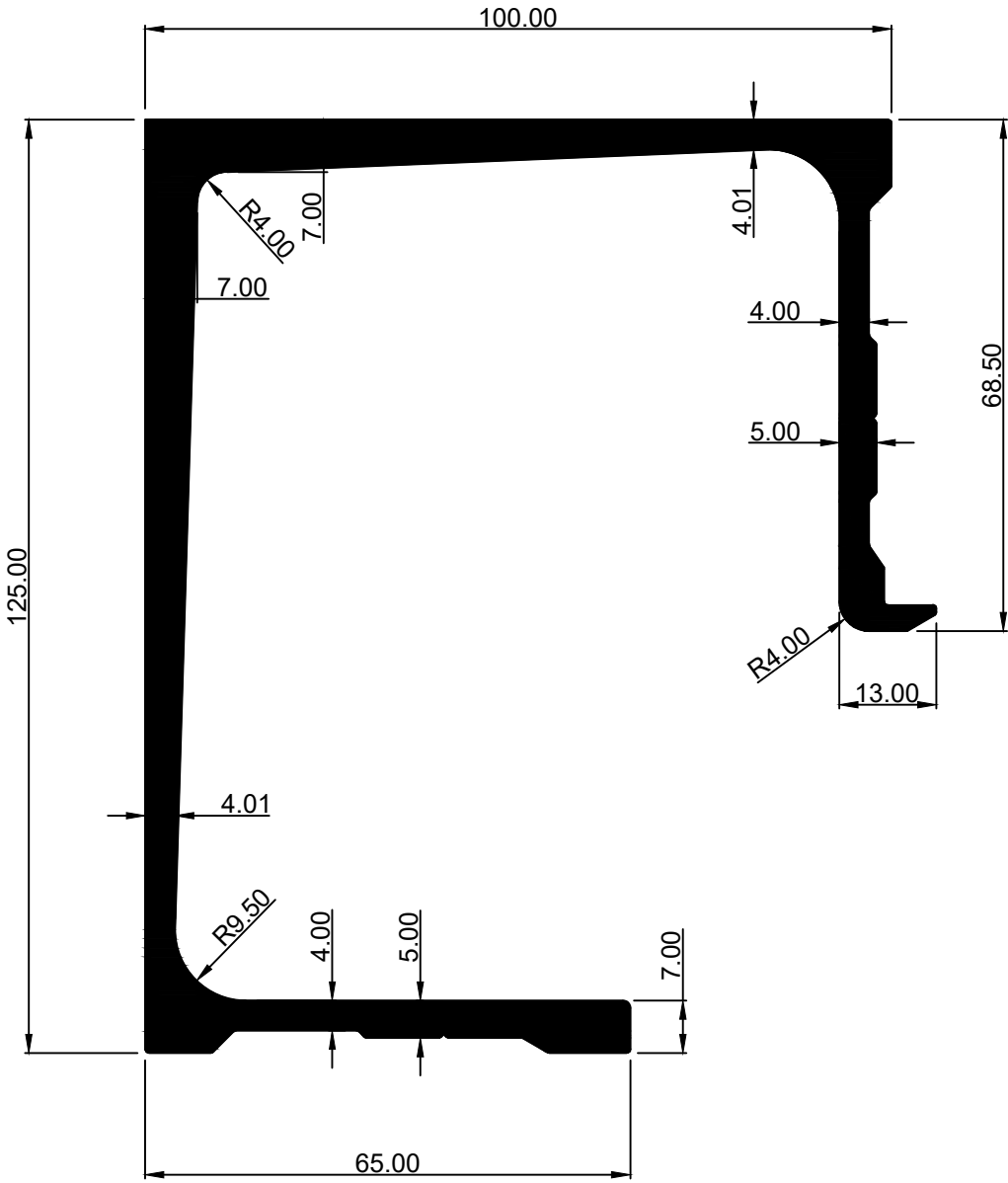

5.0607 Kg/Mtr.

SHREENATHJI EXTRUSION

SECTION No.:—SE—1028 (1030)

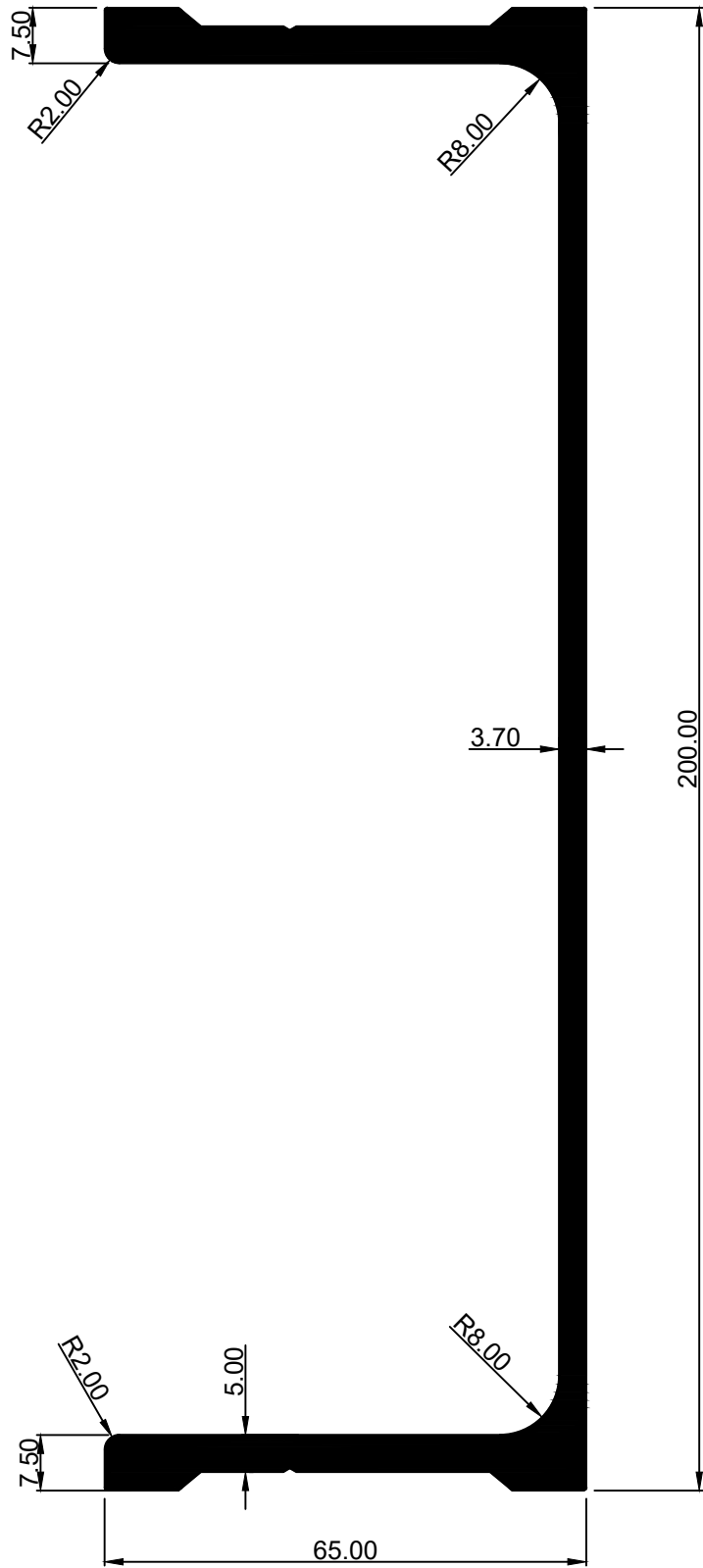

3.9804 Kg/Mtr.

SHREENATHJI EXTRUSION

SECTION No.:—SE—1030 (1072)

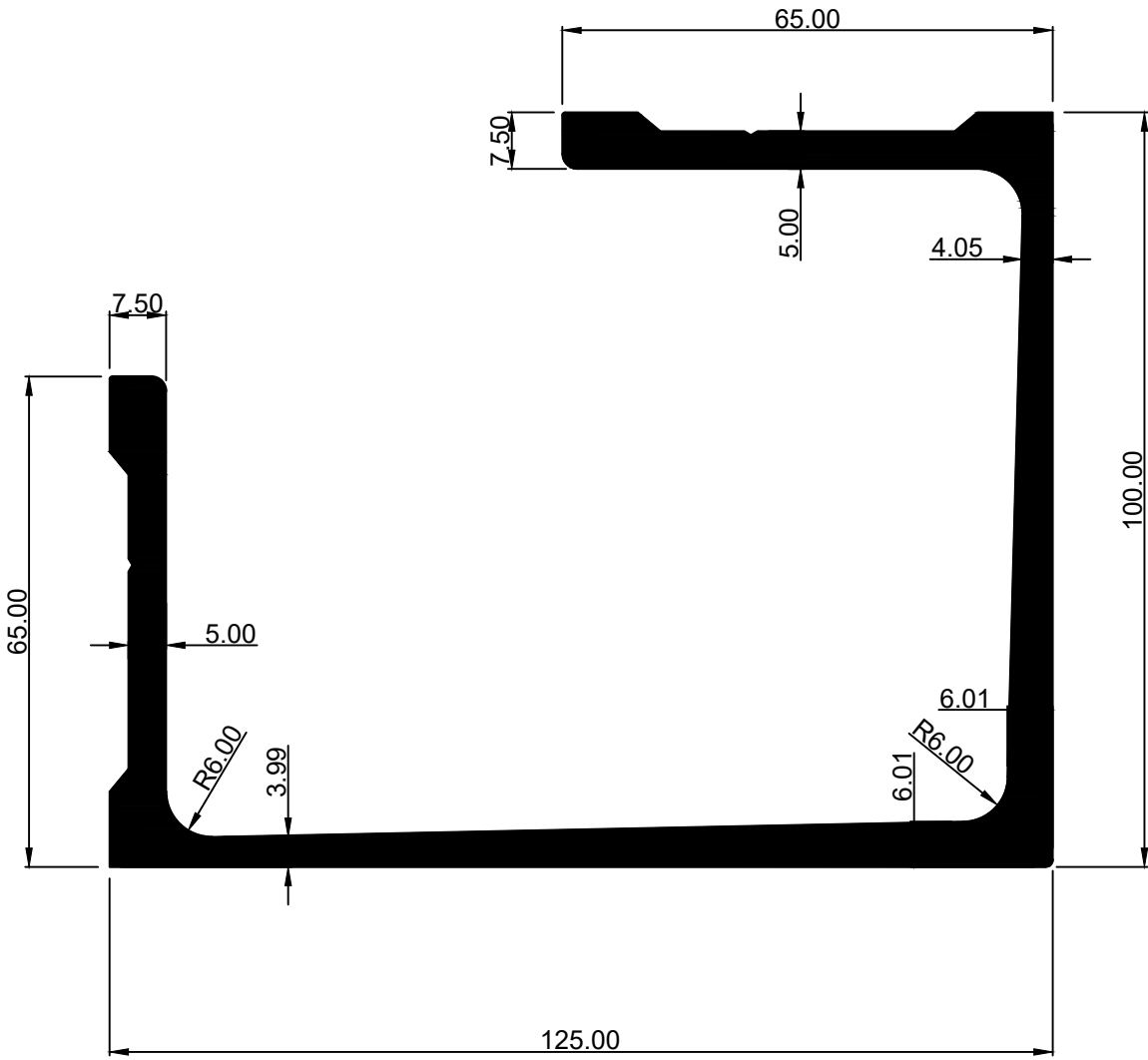

4.8955 Kg/Mtr.

SHREENATHJI EXTRUSION

SECTION No.:—SE—1052 (1025)

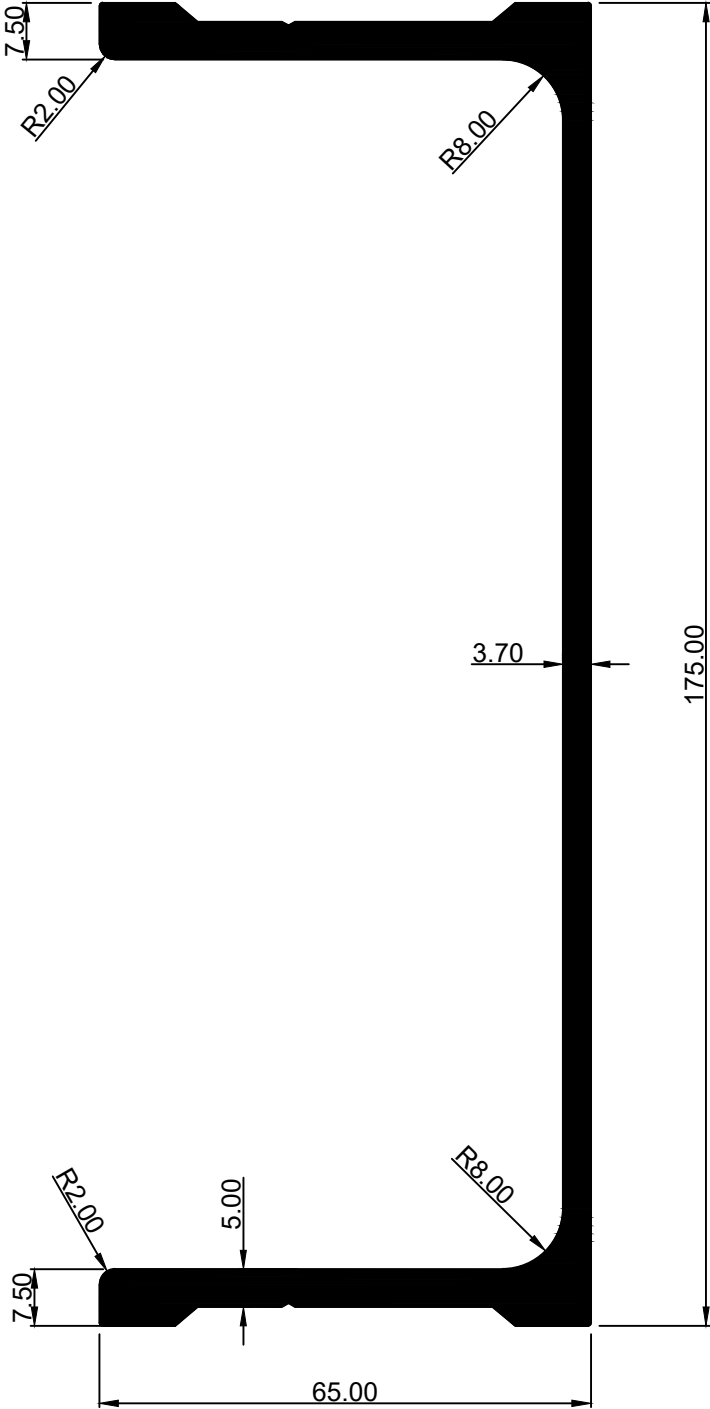

3.7307 Kg/Mtr.

SHREENATHJI EXTRUSION

SECTION No.: -SE-1110

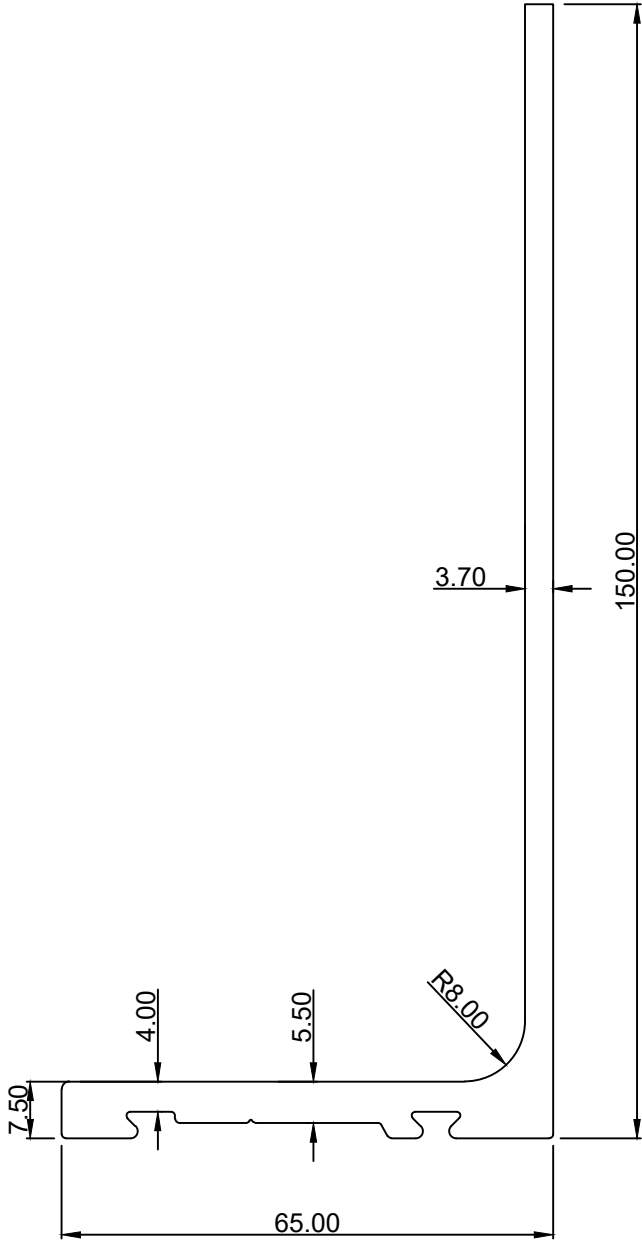

2.5271 Kg/Mtr.

SHREENATHJI EXTRUSION

SECTION No.:--SE-1111

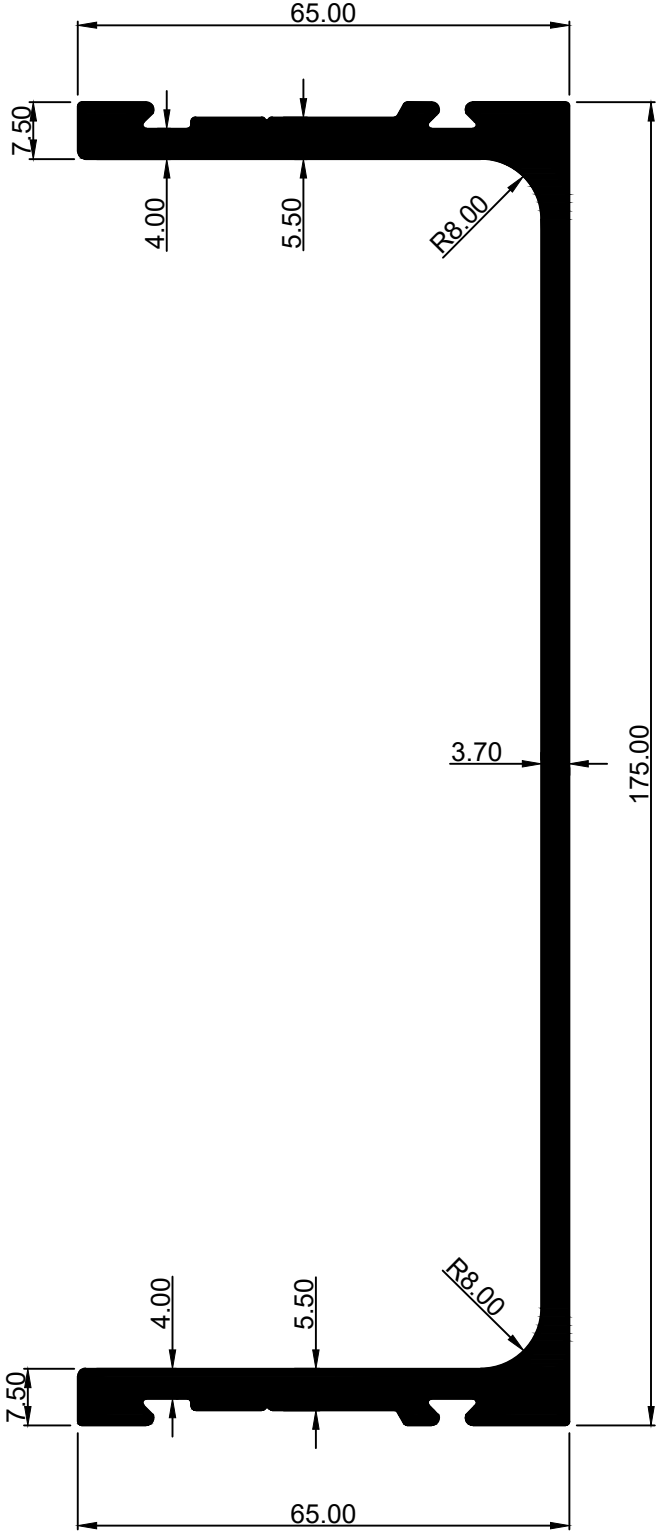

3.8052 Kg/Mtr.

SHREENATHJI EXTRUSION

SECTION No.:—SE—1112

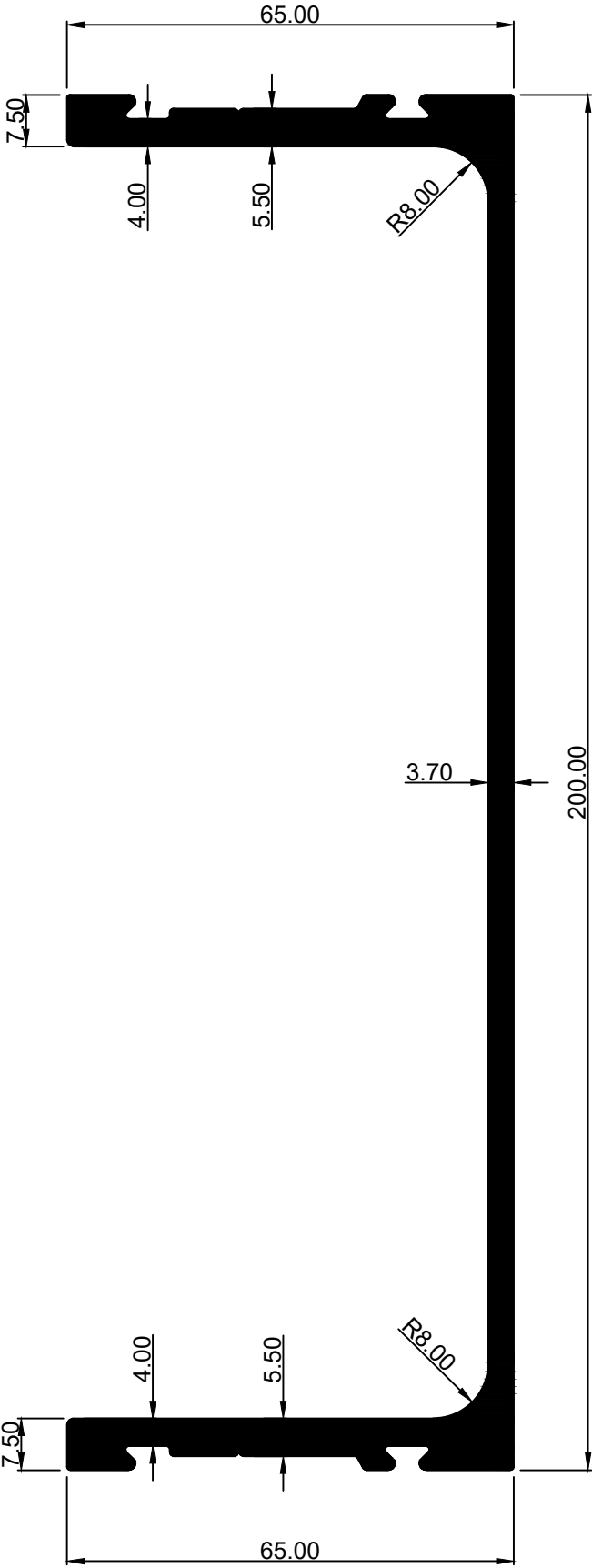

4.0550 Kg/Mtr.

SHREENATHJI EXTRUSION

SECTION No.:– SE-1138



4.0009 Kg/12'

SECTION No.:– SE-1140

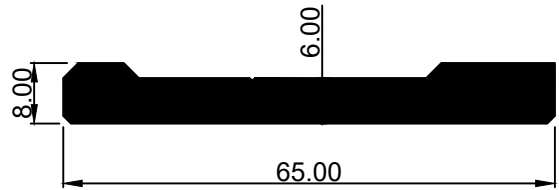

4.3172 Kg/12'

SECTION No.:– SE-1141

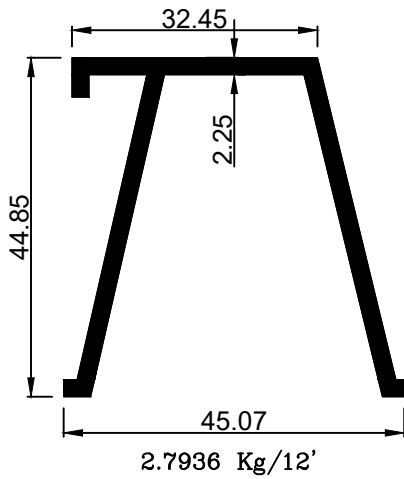

2.7936 Kg/12'

SECTION No.:– SE-1142

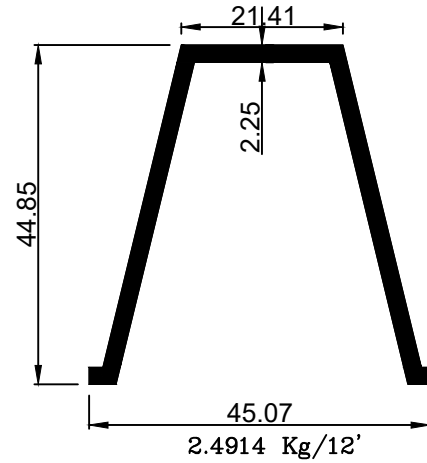

2.4914 Kg/12'

SECTION No.:– SE-1257

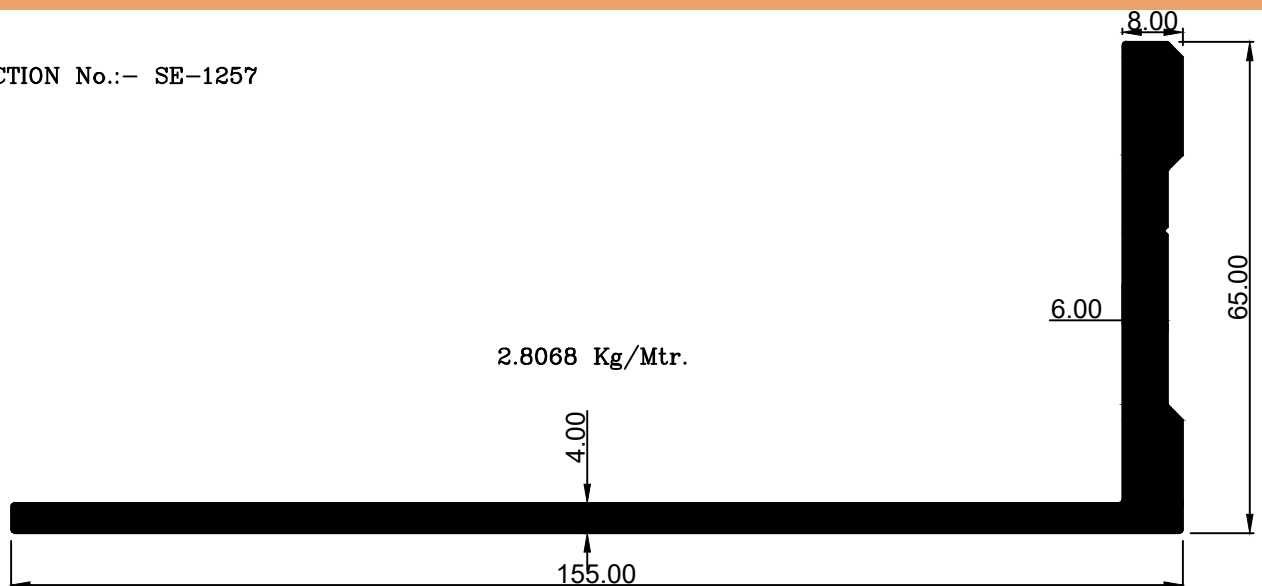

2.8068 Kg/Mtr.

SHREENATHJI EXTRUSION

SECTION No.:- SE-1258

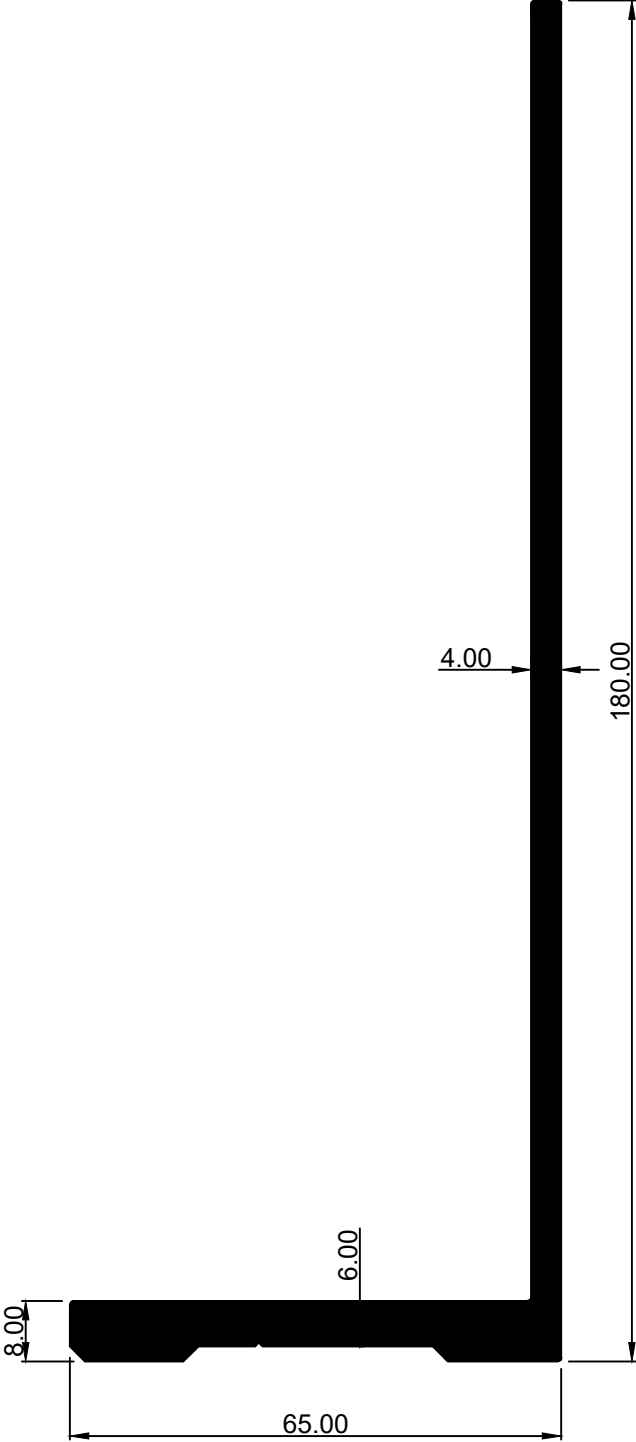

3.0768 Kg/Mtr.

SHREENATHJI EXTRUSION

SECTION No.:- SE-1259

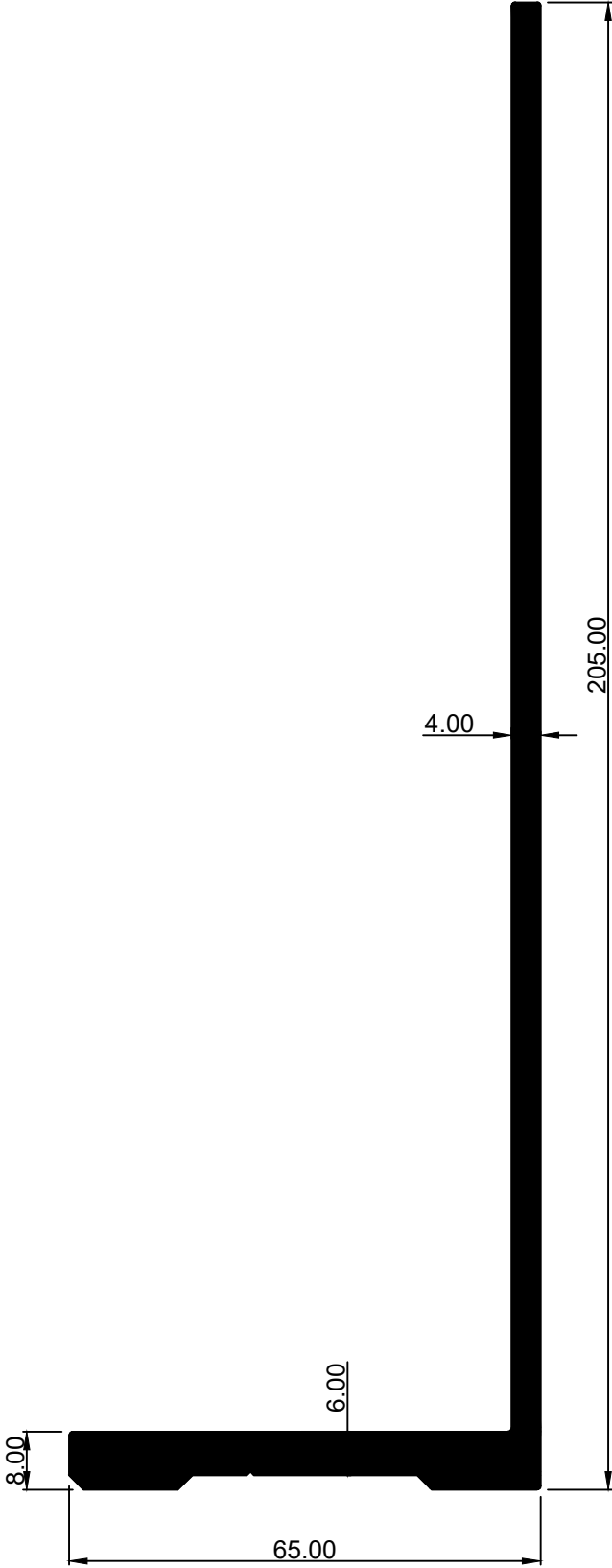

3.3468 Kg/Mtr.

SHREENATHJI EXTRUSION

SECTION No.:- SE-1260

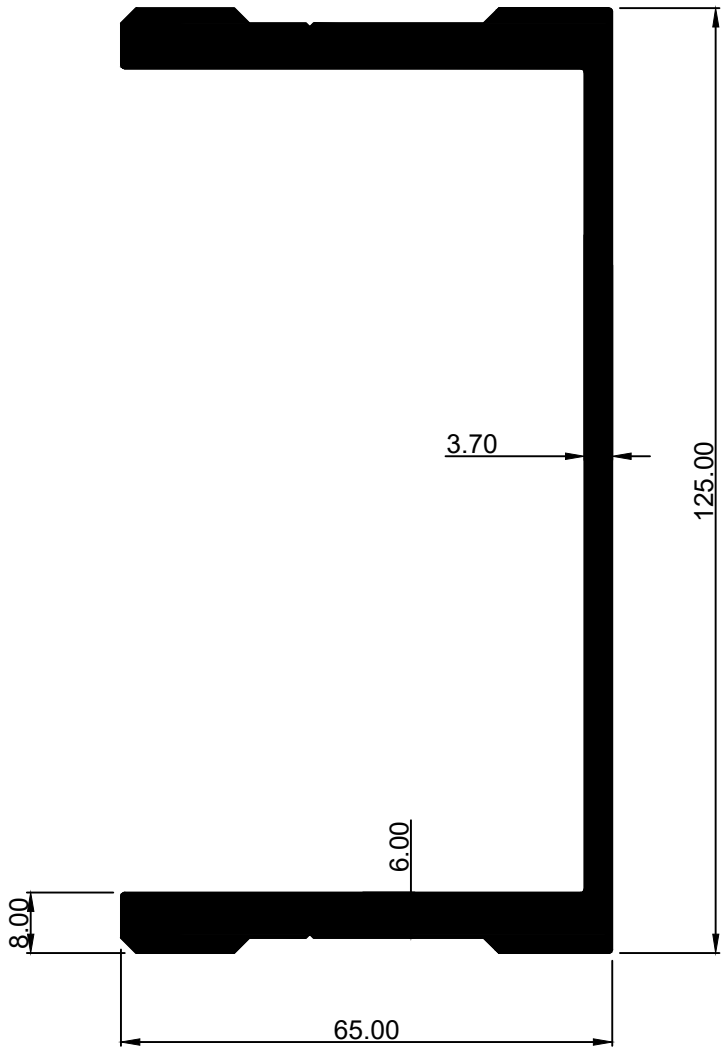

3.5280 Kg/Mtr.

SHREENATHJI EXTRUSION

SECTION No.:- SE-1261

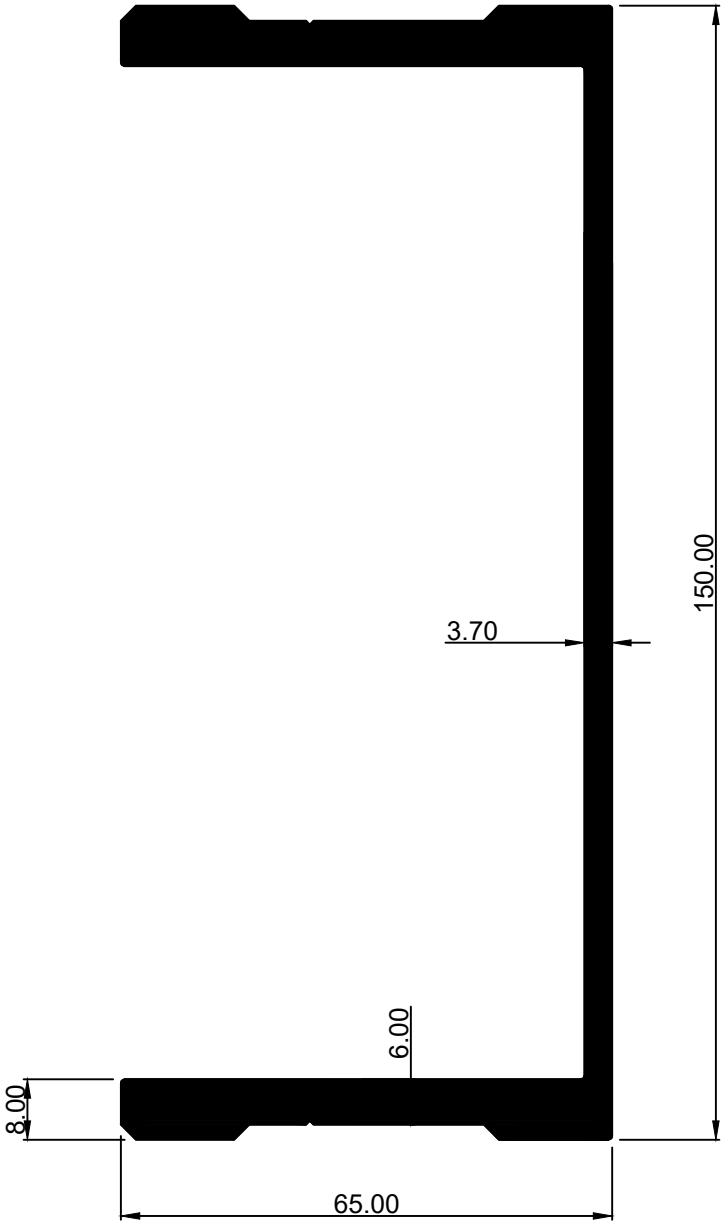

3.7778 Kg/Mtr.

SHREENATHJI EXTRUSION

SECTION No.:- SE-1262

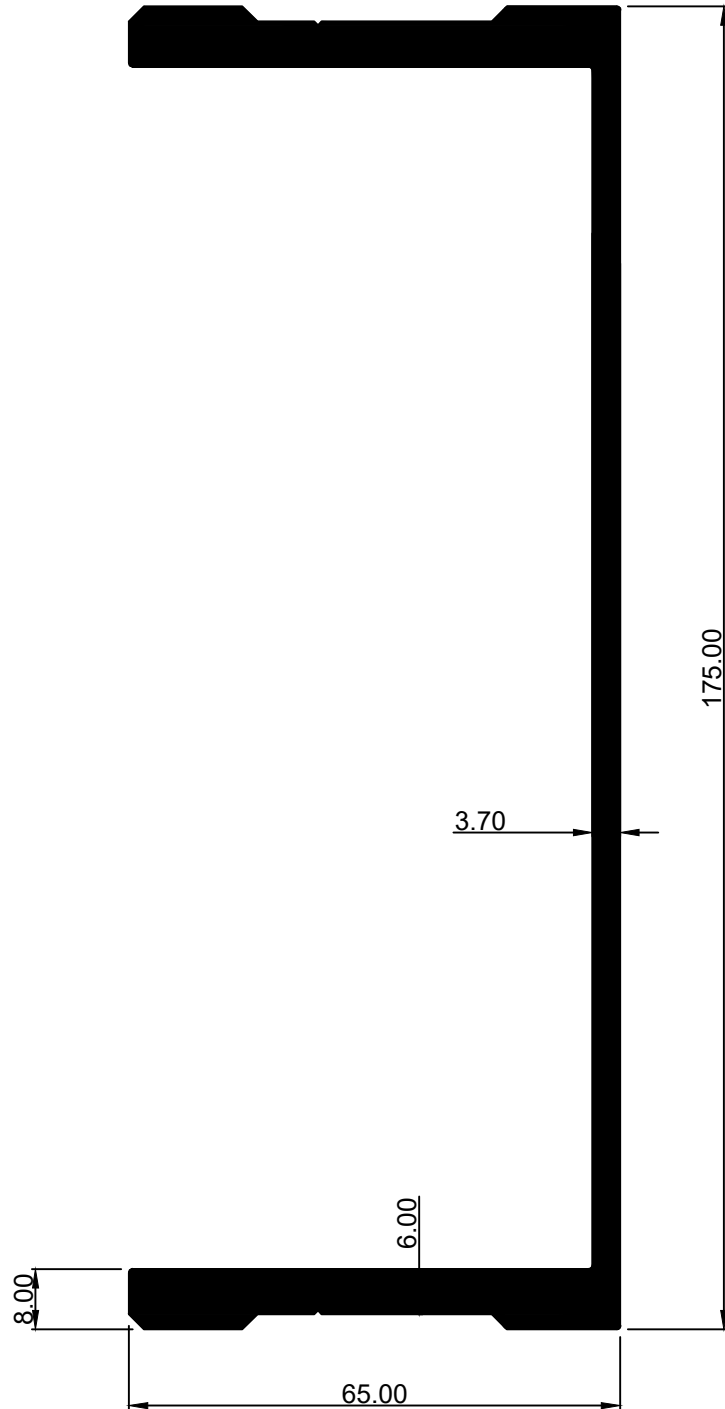

4.0275 Kg/Mtr.

SHREENATHJI EXTRUSION

SECTION No.:- SE-1263

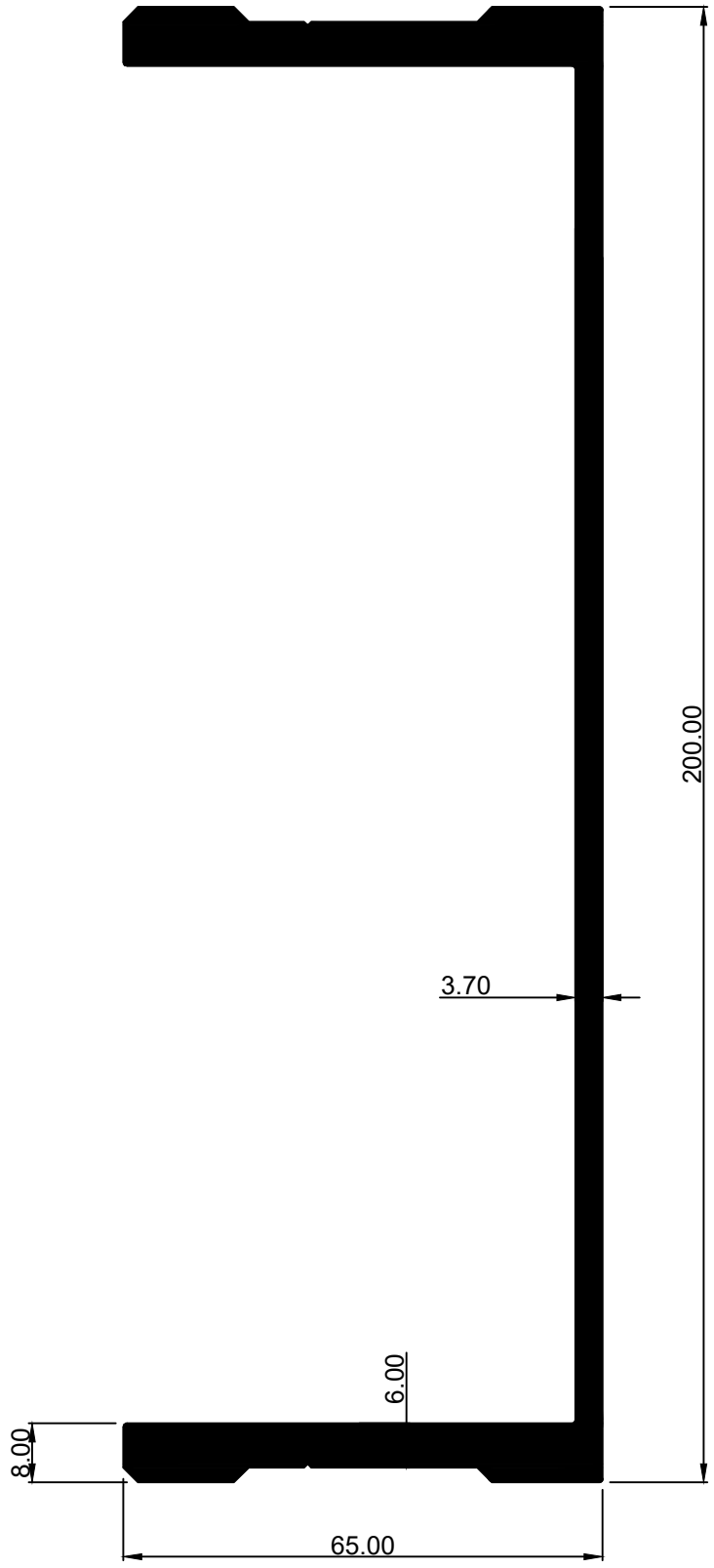

4.2773 Kg/Mtr.

SHREENATHJI EXTRUSION

SECTION No.:- SE-1270

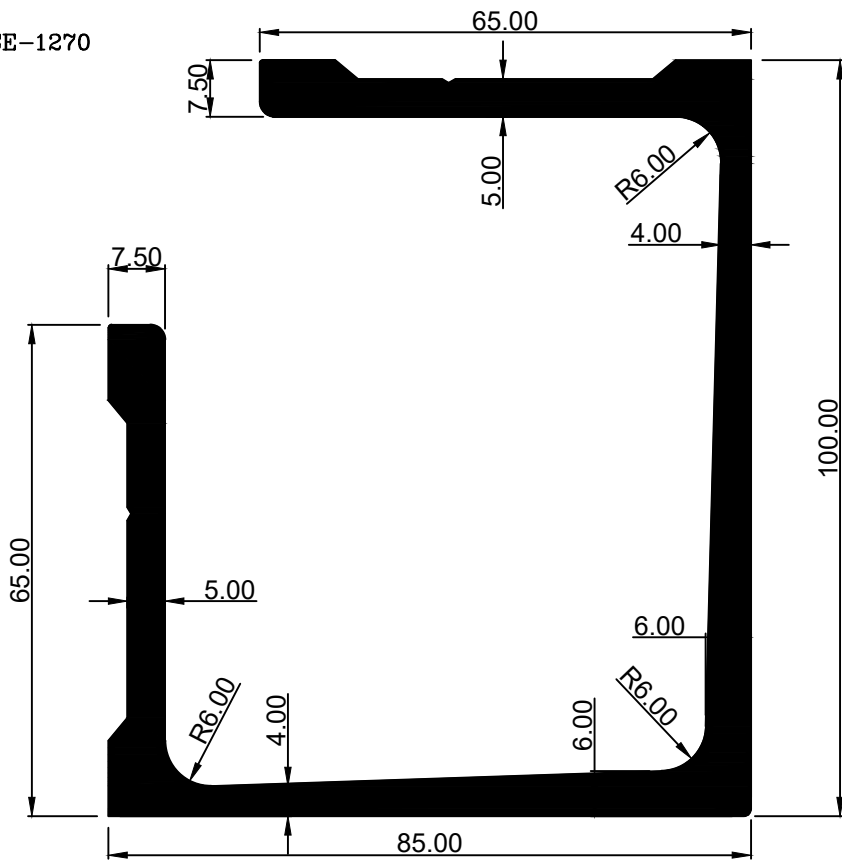

4.3485 Kg/Mtr.

SECTION No.:- SE-1283

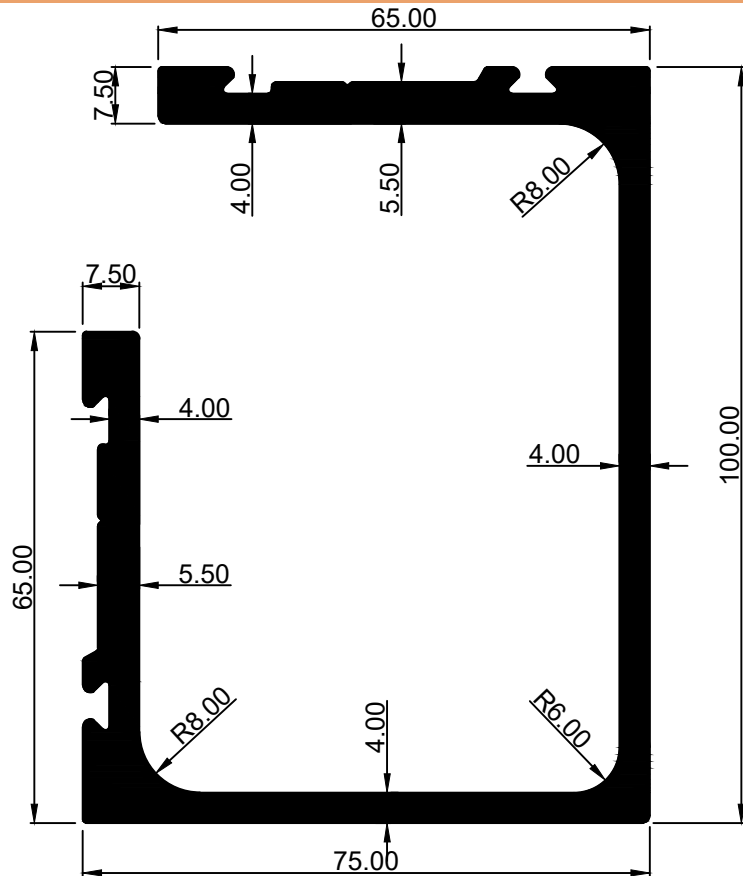

3.9120 Kg/Mtr,

SHREENATHJI EXTRUSION

SECTION No.:- SE-1284

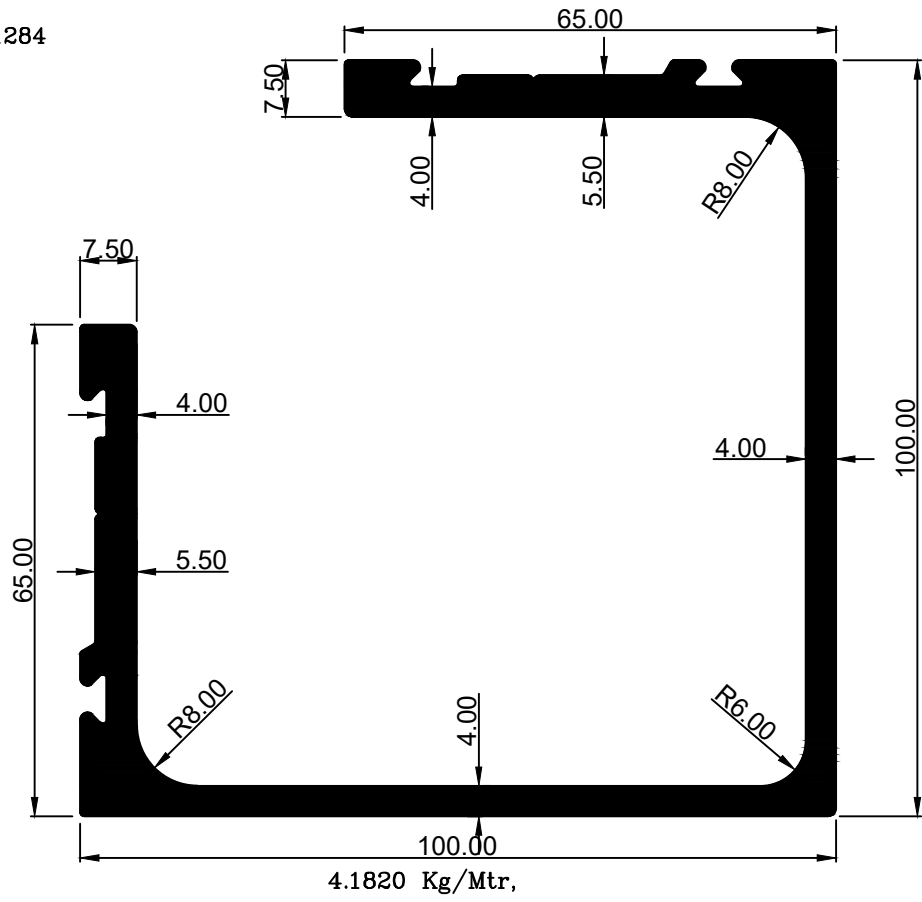

SECTION No.:- SE-1285

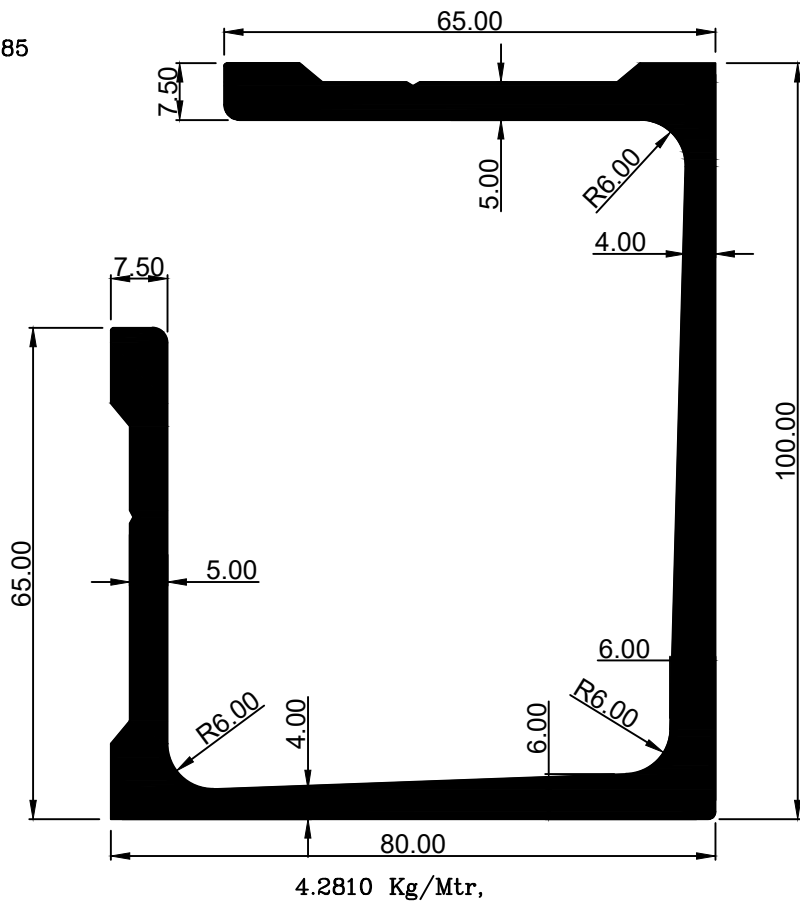

SHREENATHJI EXTRUSION

SECTION No.:- SE-1286

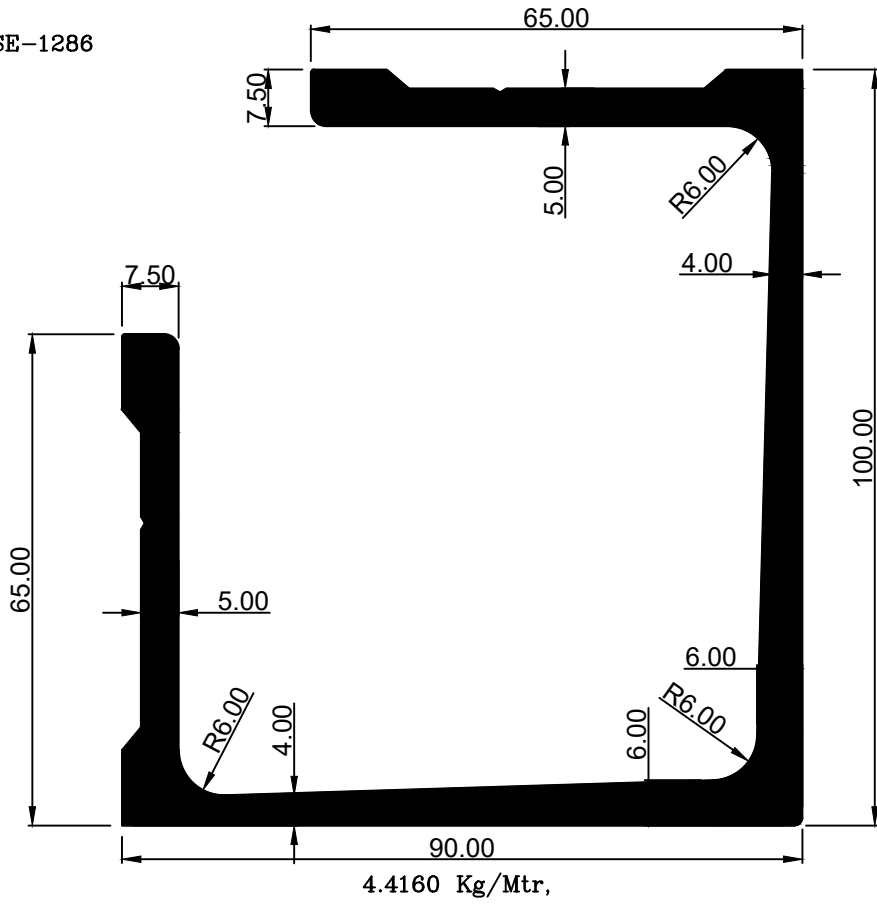

SECTION No.:- SE-1287

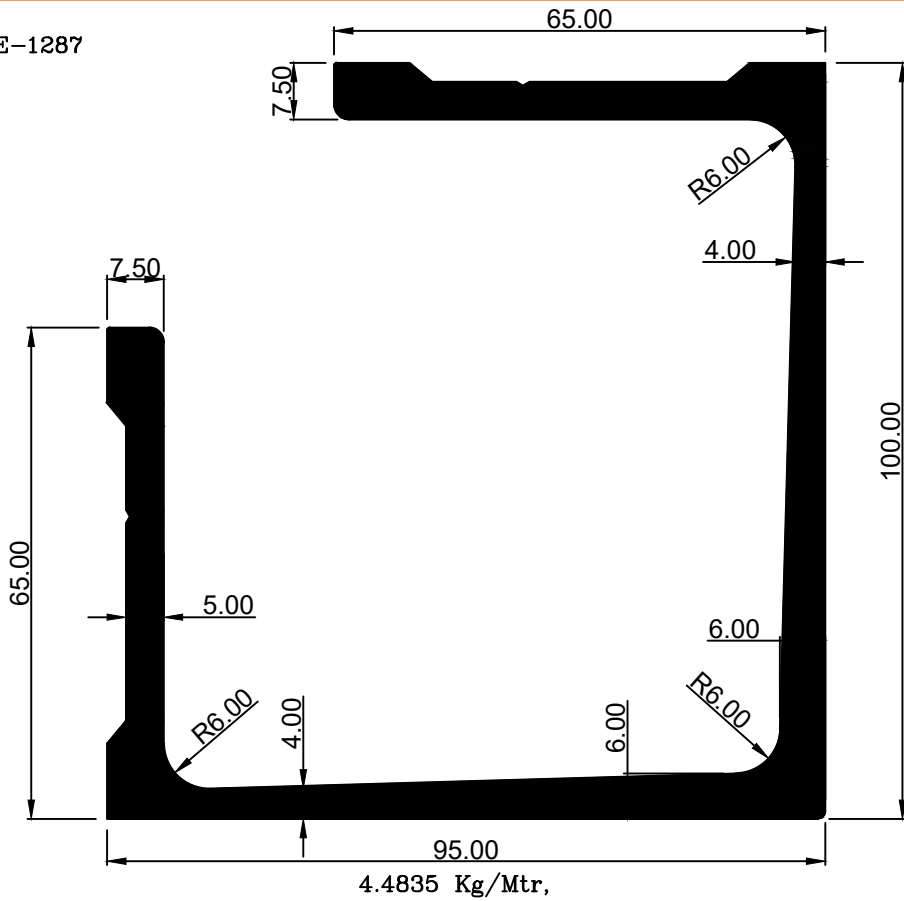

SHREENATHJI EXTRUSION

SECTION No.:- SE-1381

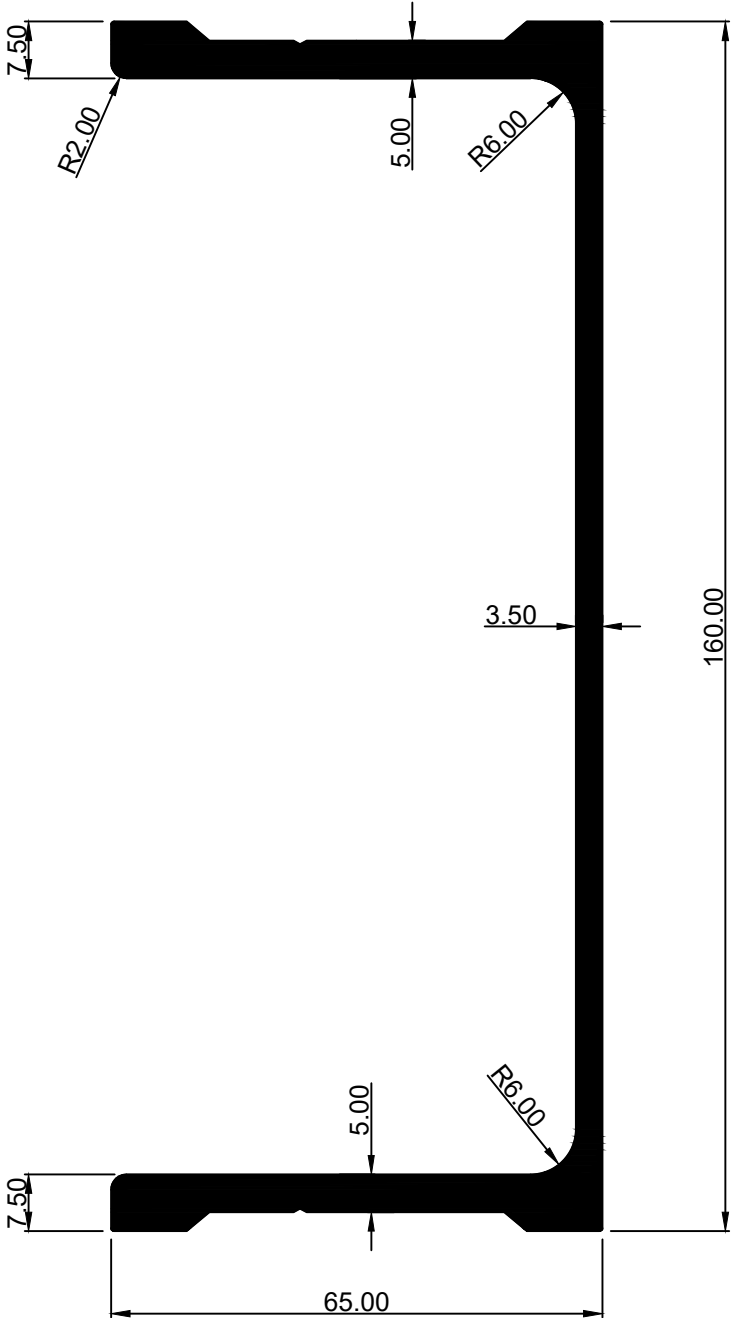

3.4701 Kg/Mtr.

SHREENATHJI EXTRUSION

SECTION No.:- SE-1382

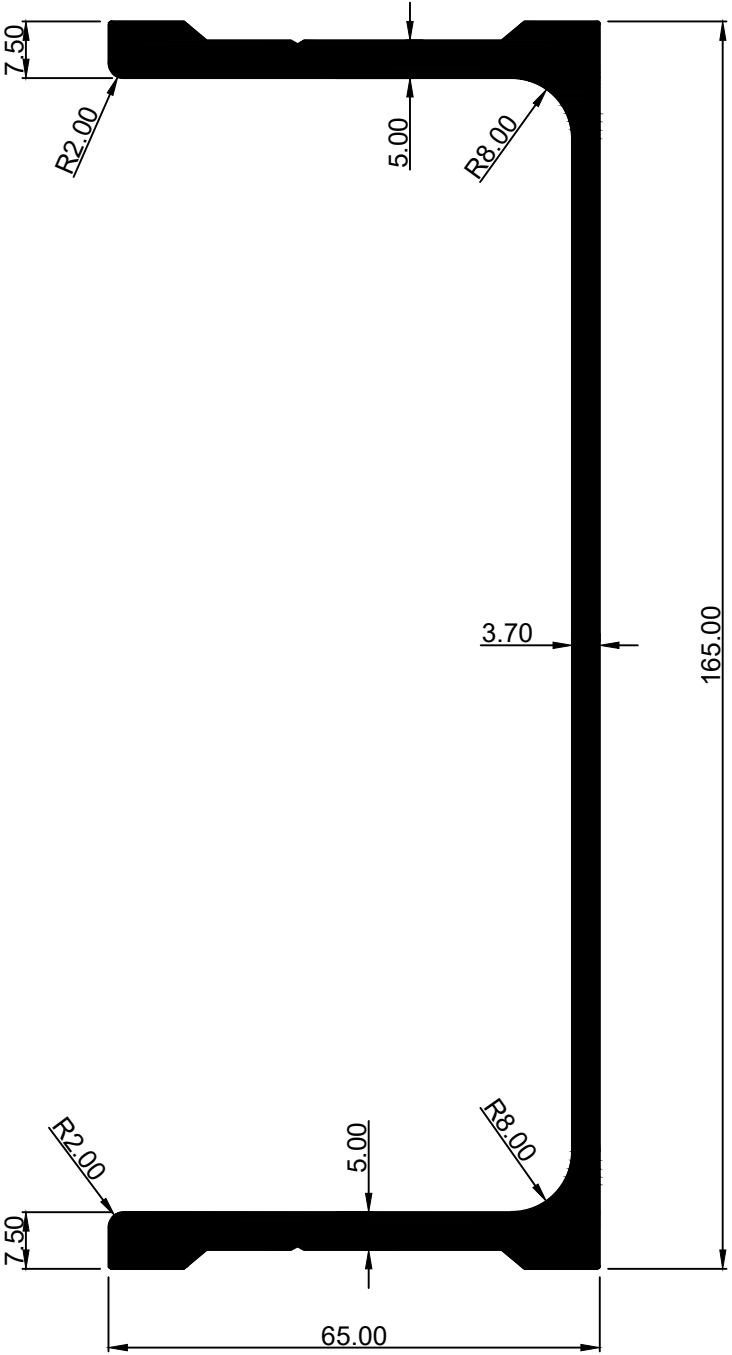

3.6308 Kg/Mtr.

SHREENATHJI EXTRUSION

SECTION No.:- SE-1383

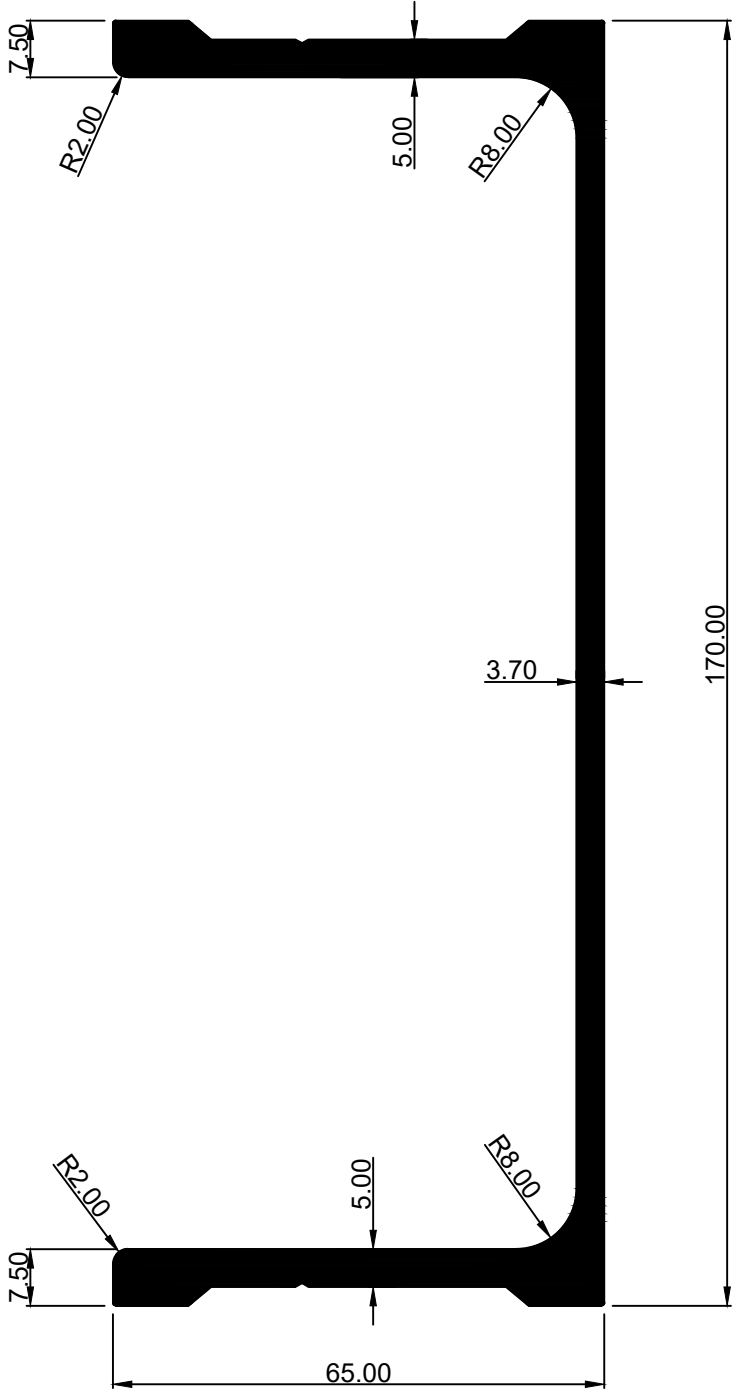

3.6807 Kg/Mtr.

SHREENATHJI EXTRUSION

SECTION No.:- SE-1384

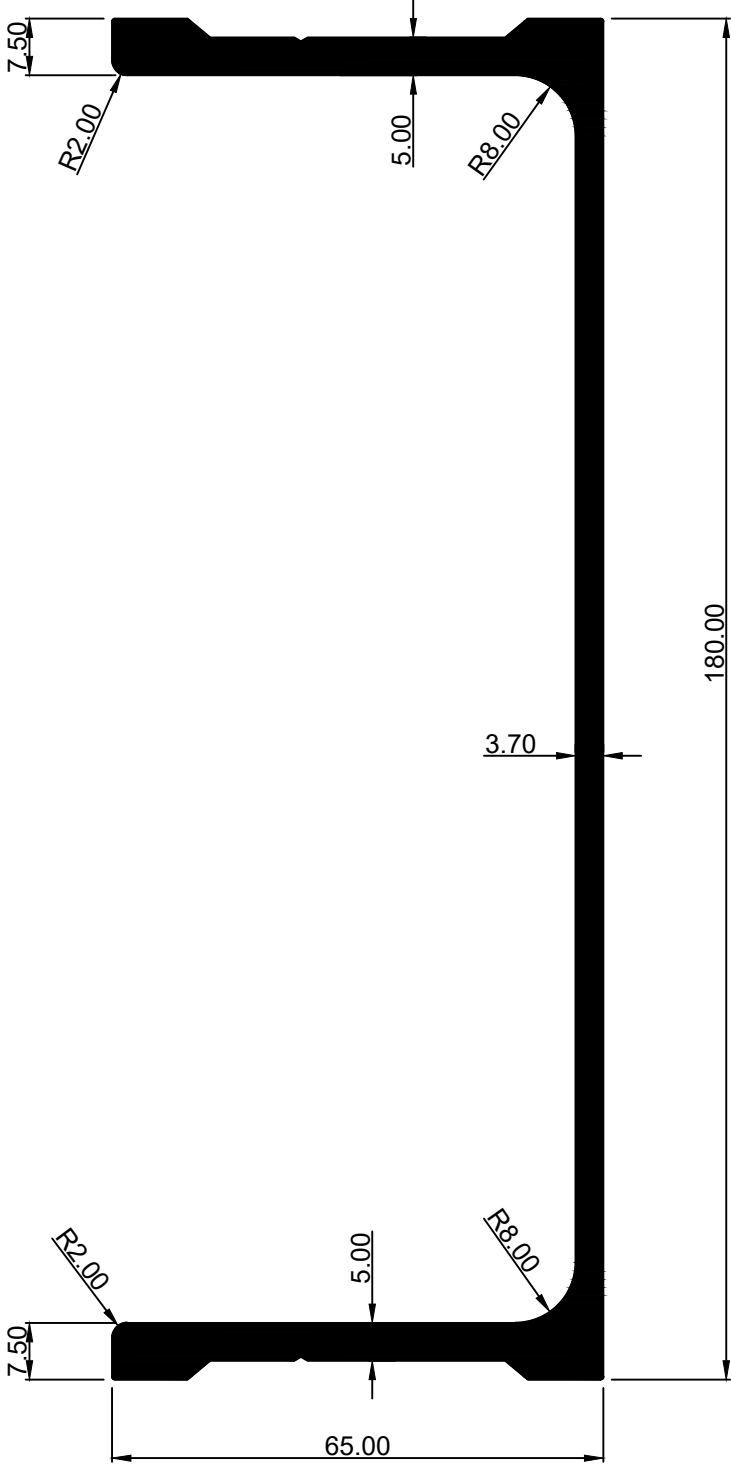

3.7806 Kg/Mtr.

SHREENATHJI EXTRUSION

SECTION No.:- SE-1385

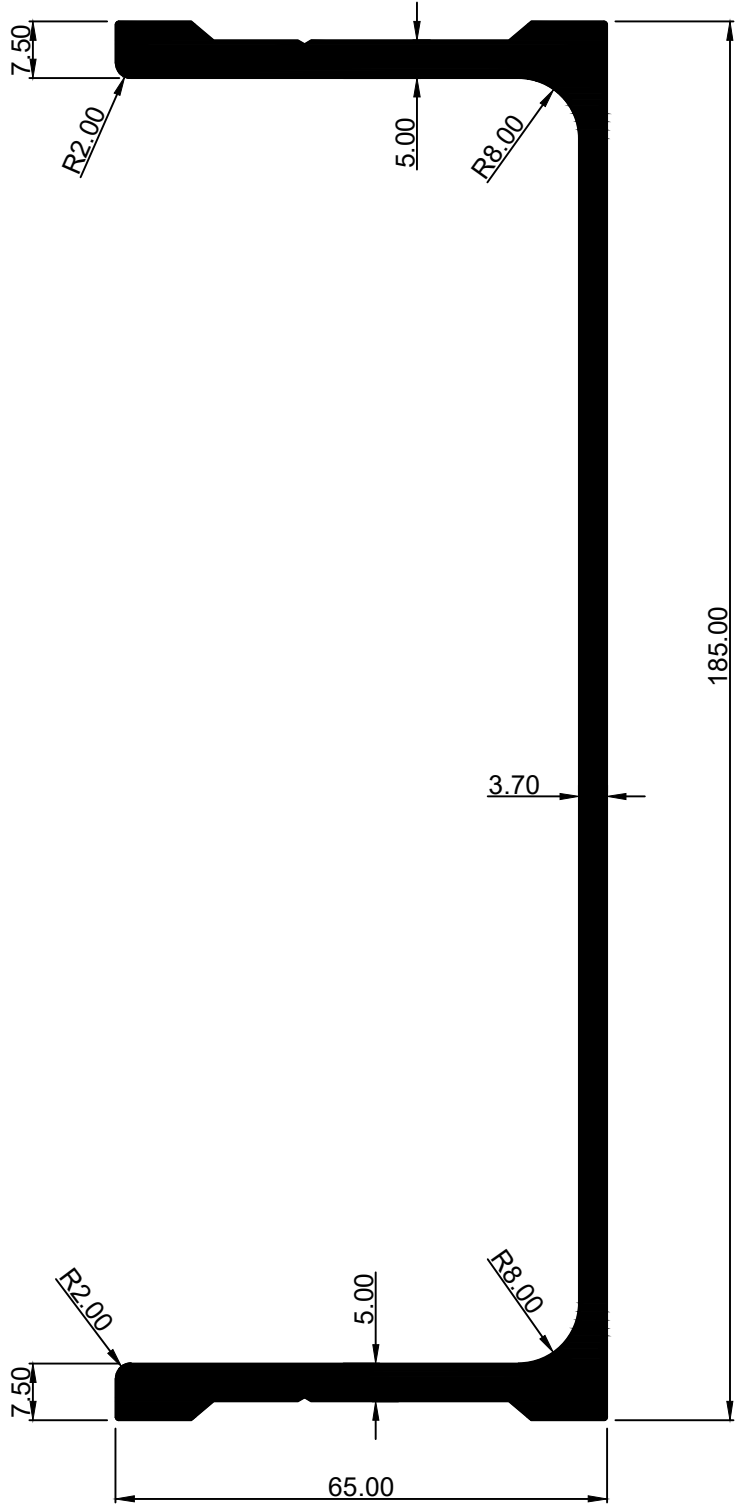

3.8306 Kg/Mtr.

SHREENATHJI EXTRUSION

SECTION No.:– SE-1386

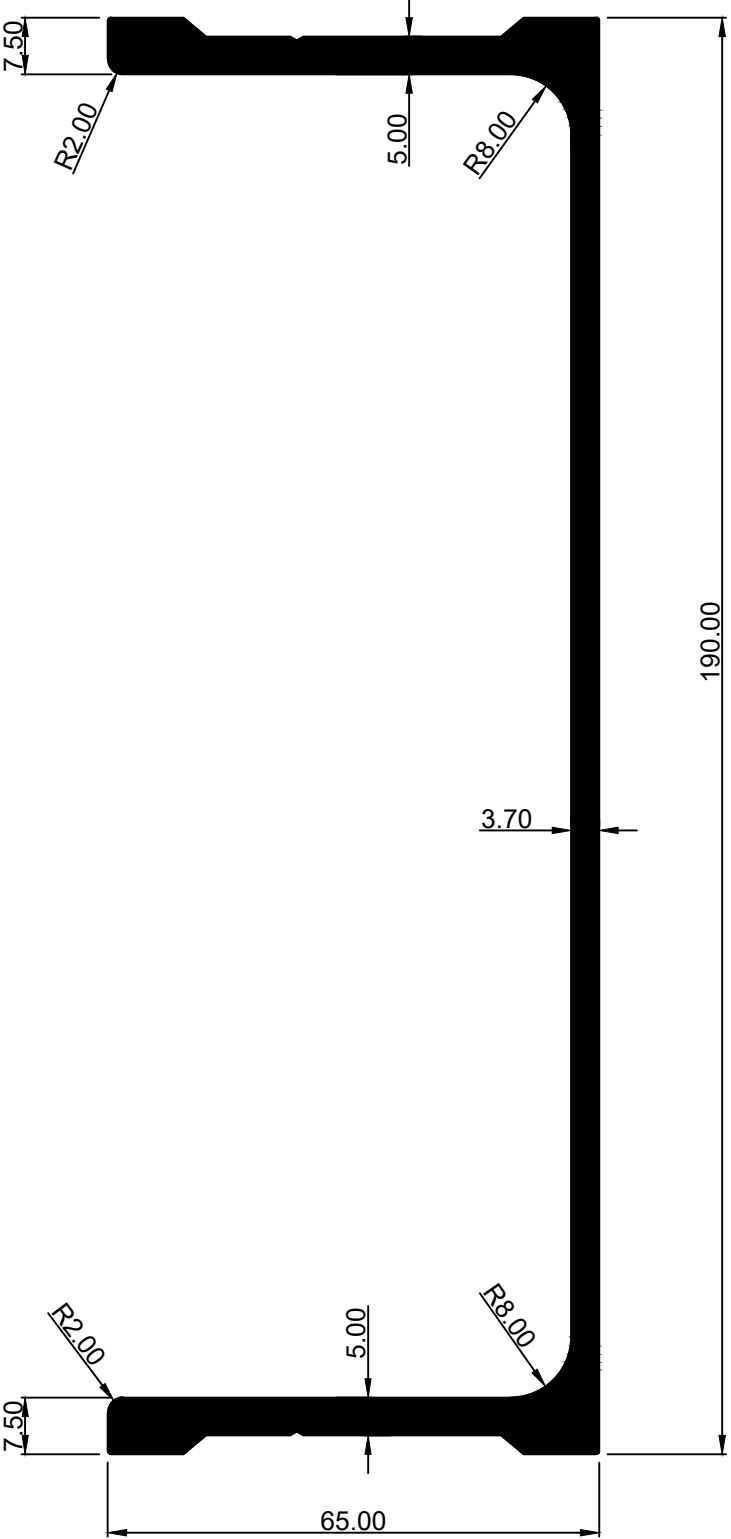

3.8805 Kg/Mtr.

SHREENATHJI EXTRUSION

SECTION No.:- SE-1394

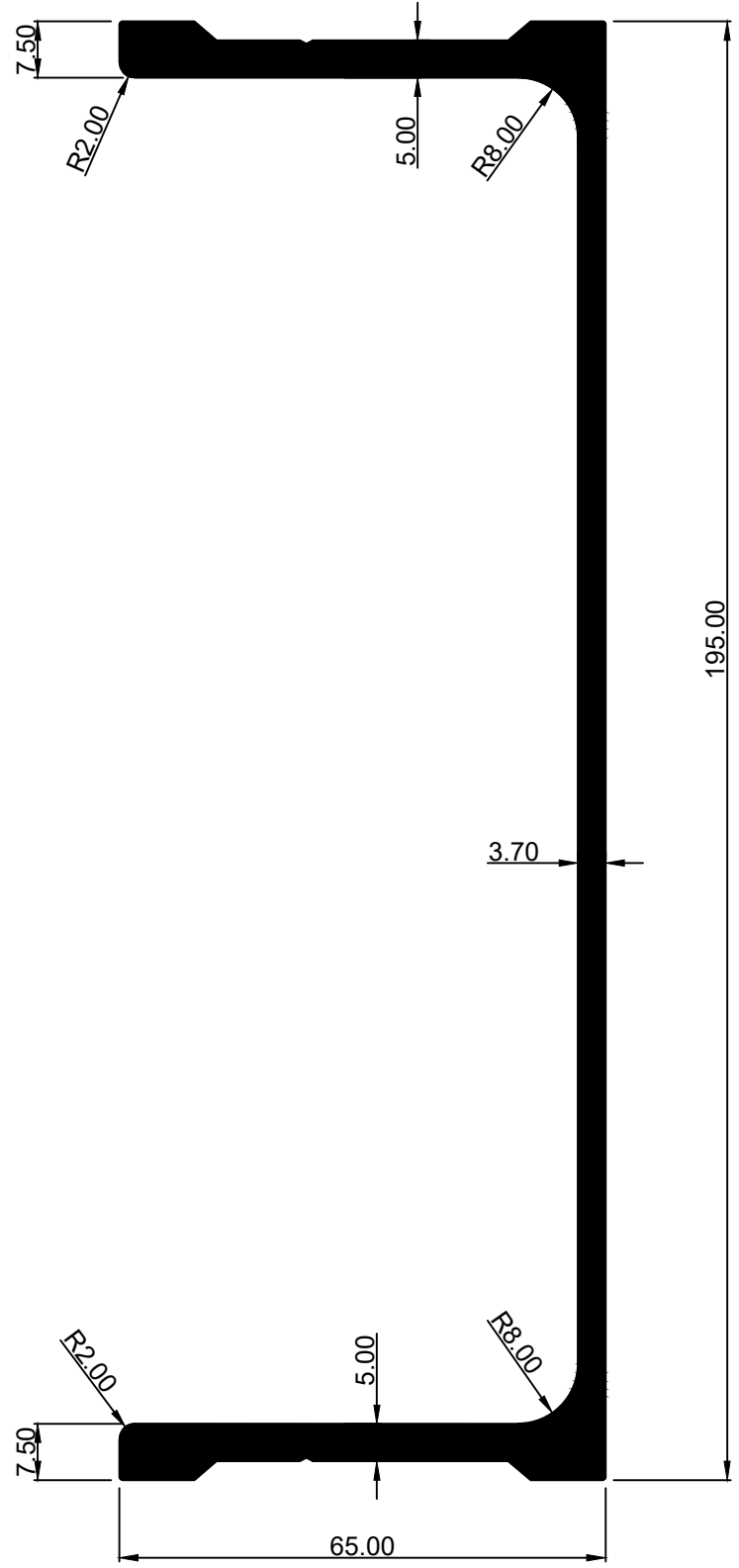

3.9305 Kg/Mtr.

SHREENATHJI EXTRUSION

SECTION NO:- SE-1408

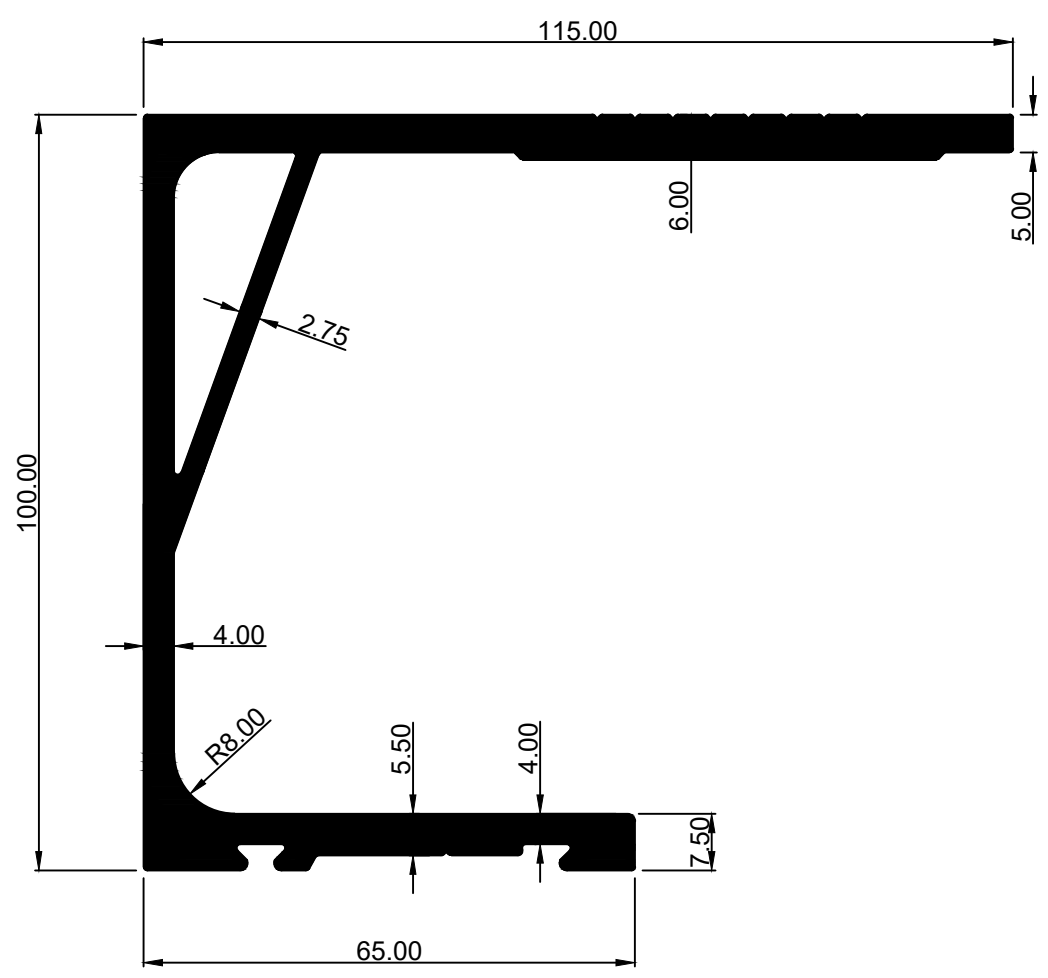

WEIGHT:- 4.1576 Kg/Mtr.

SHREENATHJI EXTRUSION

SECTION NO:- SE-1452

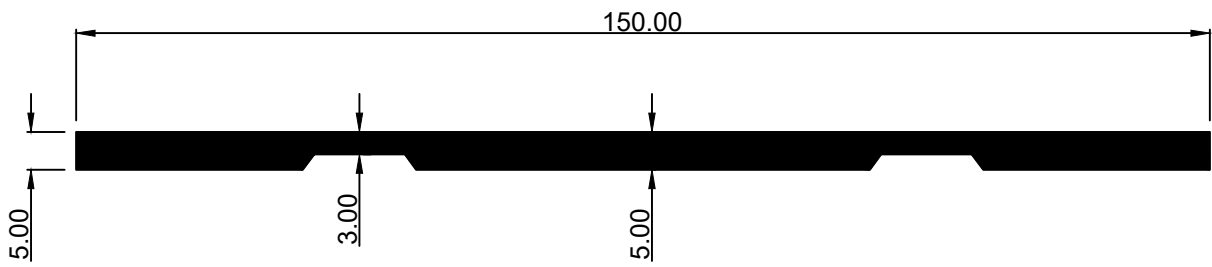

WEIGHT:- 1.8792 Kg/Mtr.

SECTION NO:- SE-1453

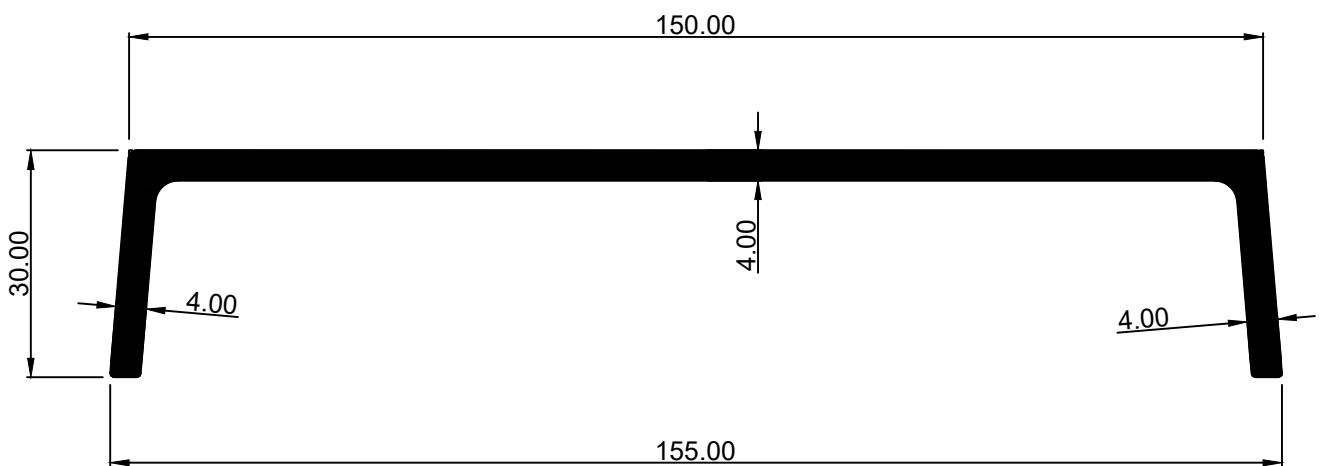

WEIGHT:- 2.1942 Kg/Mtr.

SHREENATHJI EXTRUSION

SECTION NO:- SE-1454

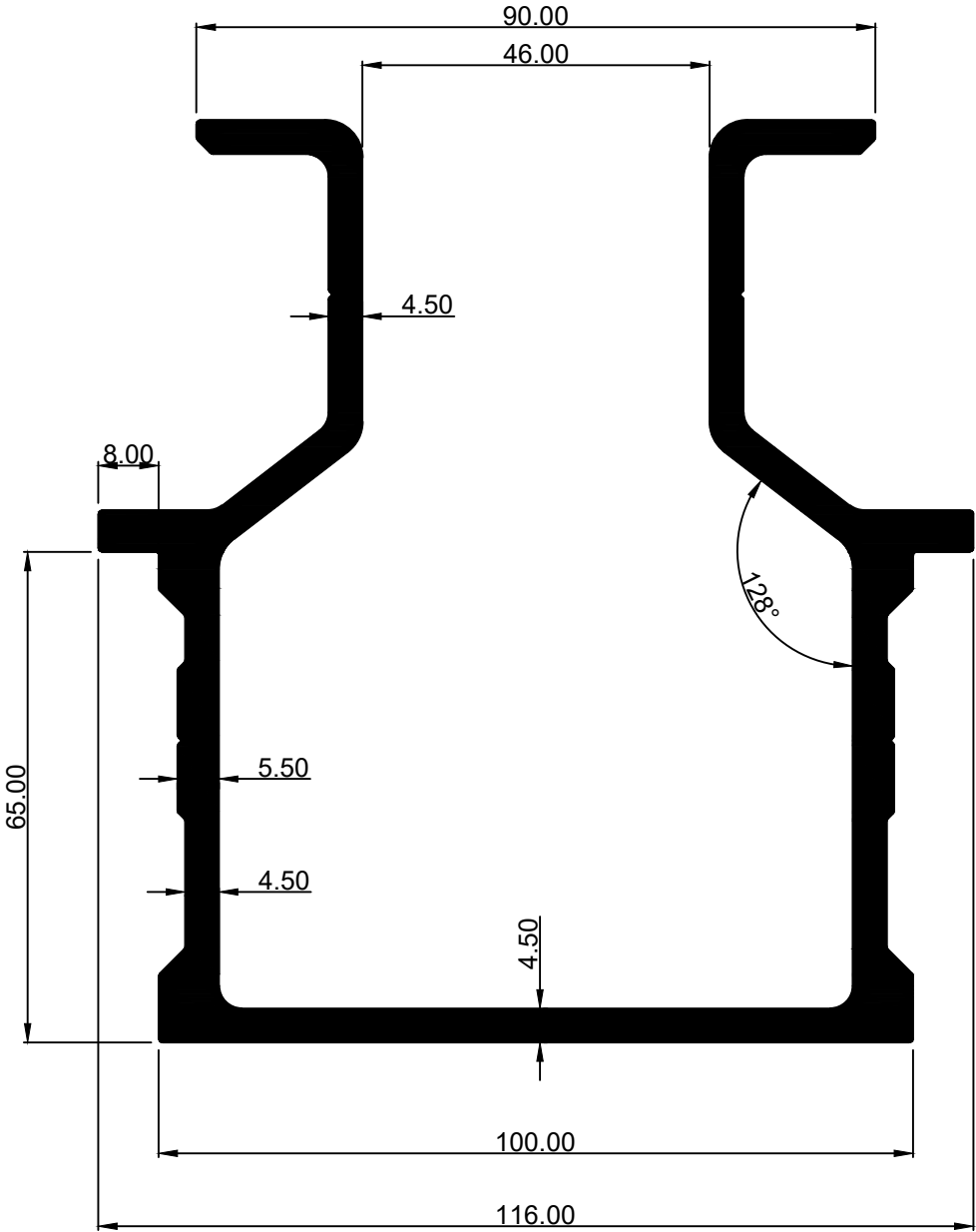

WEIGHT:- 5.4374 Kg/Mtr.

SHREENATHJI EXTRUSION

SECTION NO:- SE-1455

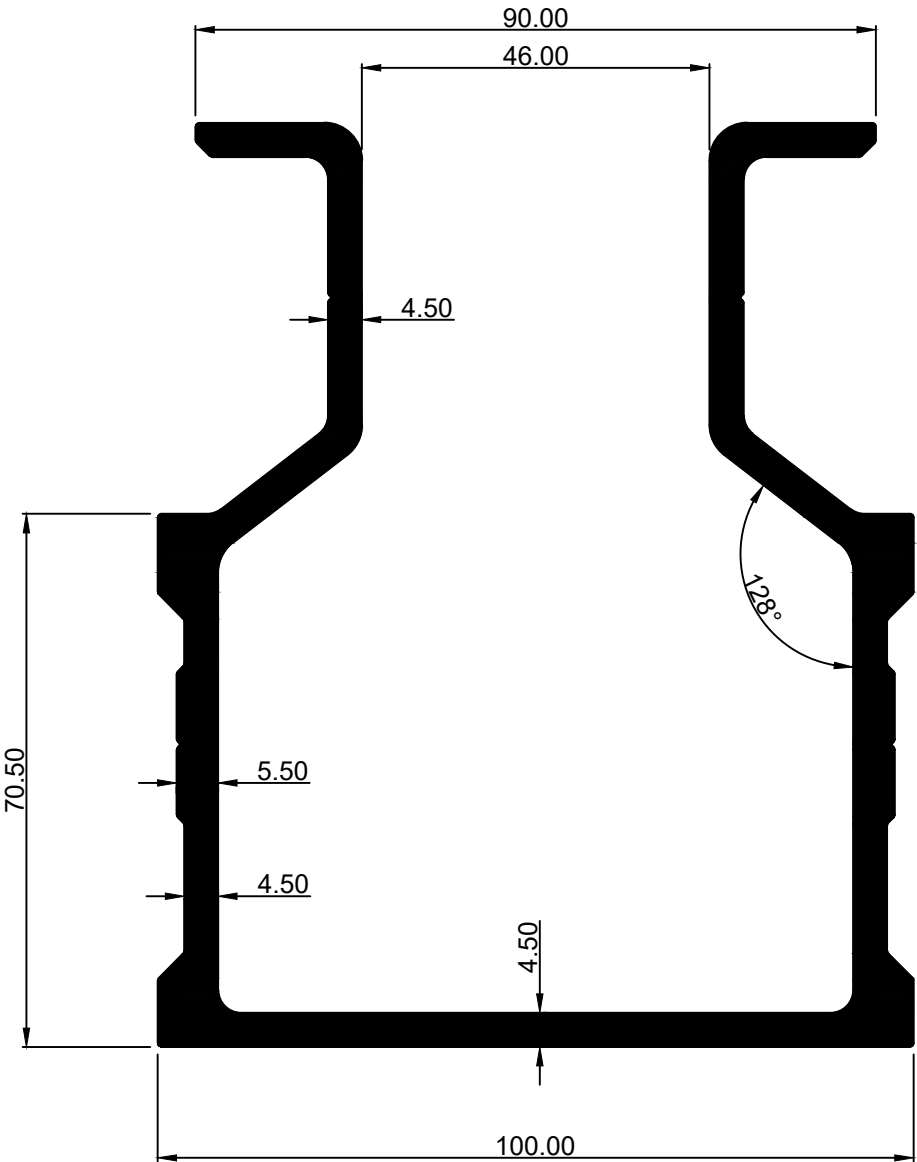

WEIGHT:- 5.1998 Kg/Mtr.

SHREENATHJI EXTRUSION

SECTION NO:- SE-1469

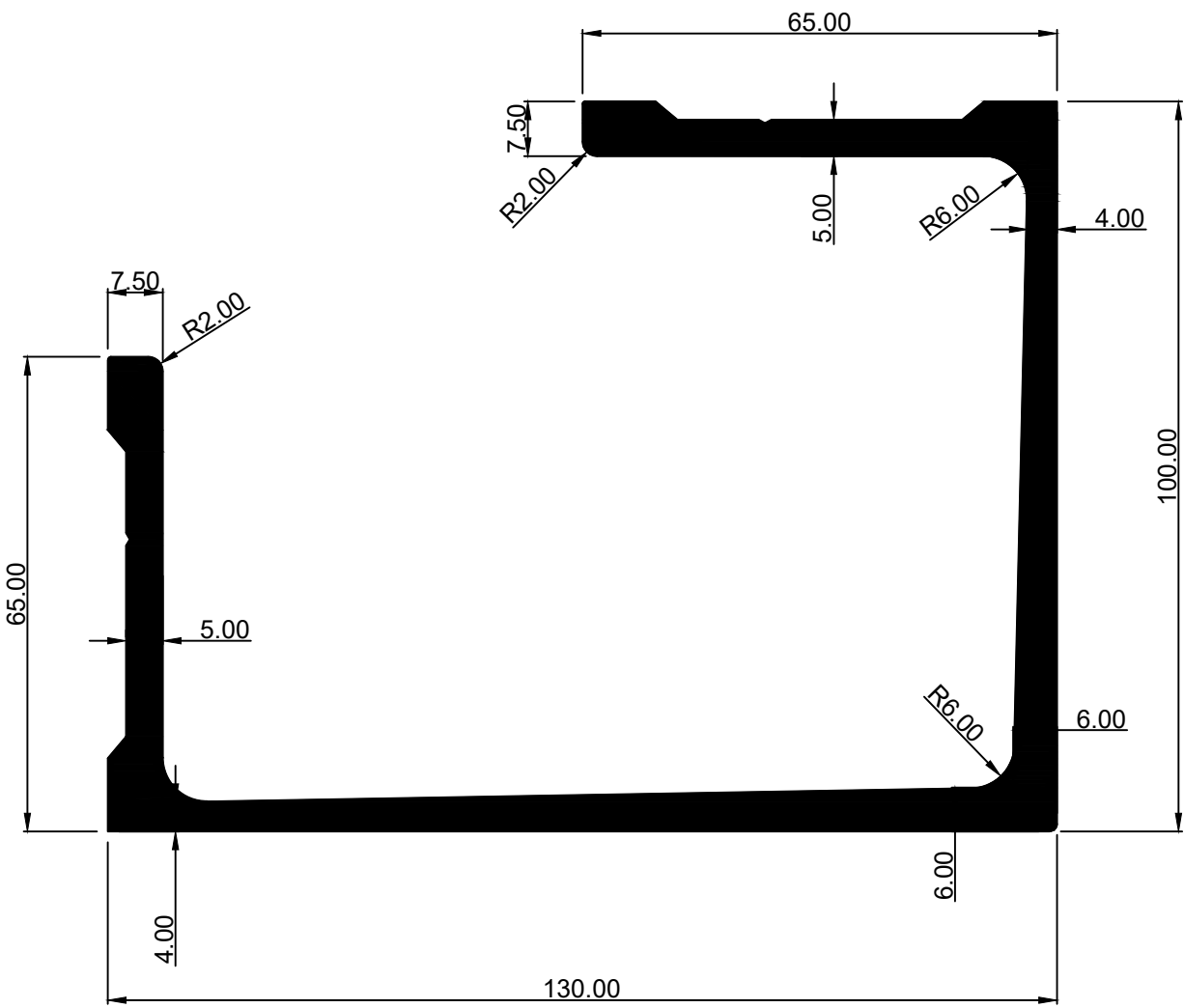

WEIGHT:- 4.9581 Kg/Mtr.

SHREENATHJI EXTRUSION

SECTION NO:- SE-1470

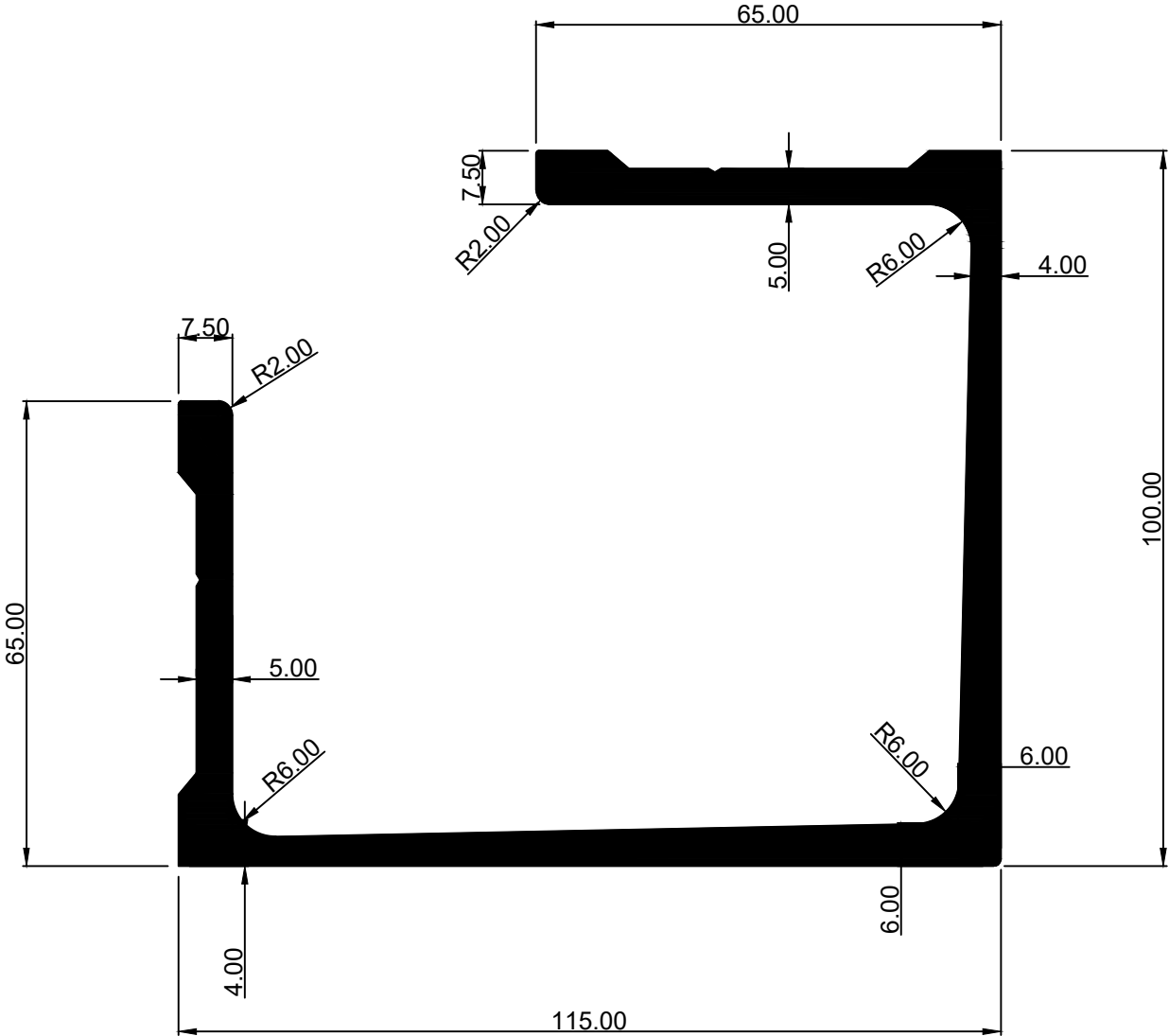

WEIGHT:- 4.7555 Kg/Mtr.

SHREENATHJI EXTRUSION

SECTION NO:- SE-1471

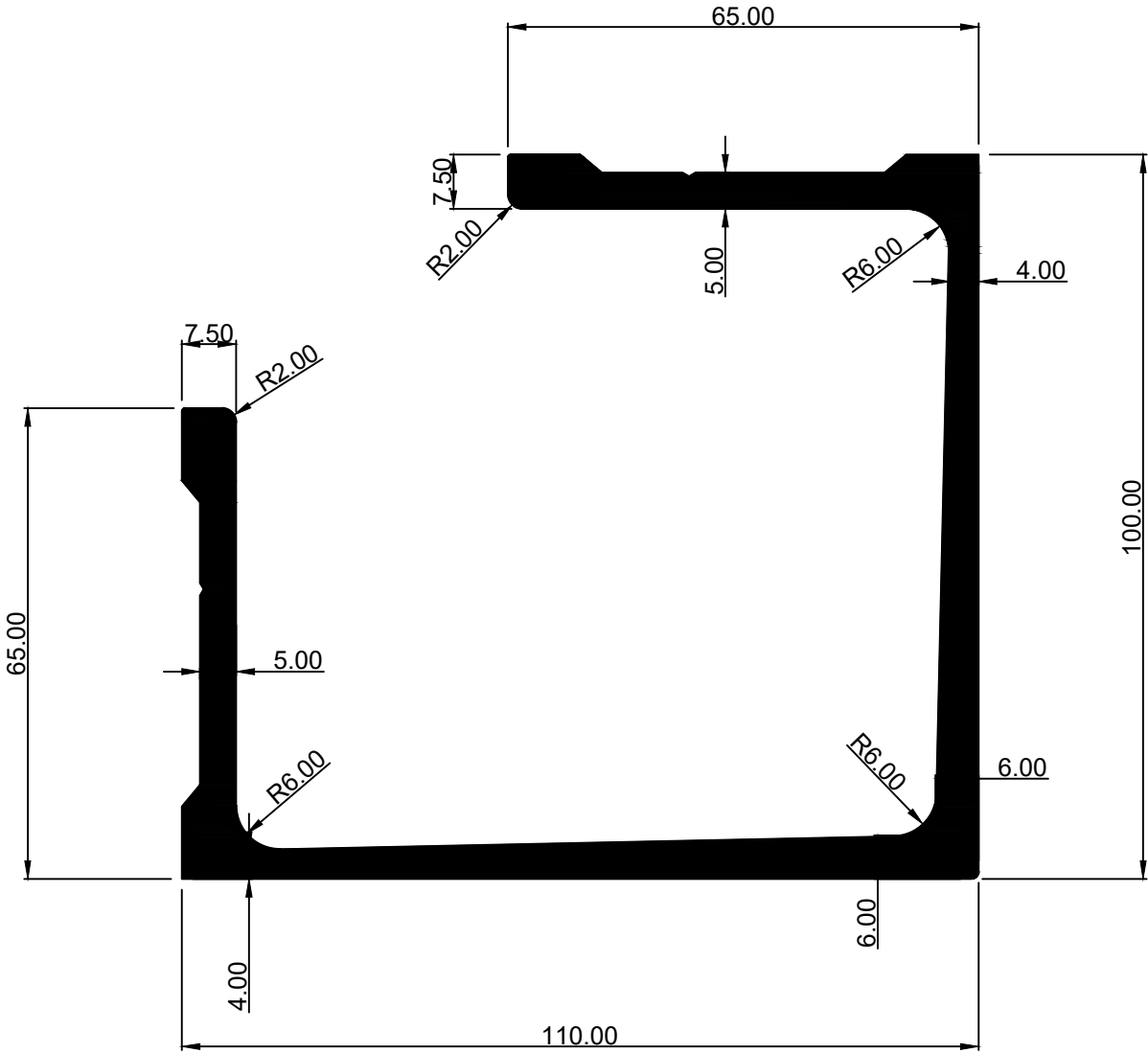

WEIGHT:- 4.6879 Kg/Mtr.

SHREENATHJI EXTRUSION

SECTION NO:- SE-1472

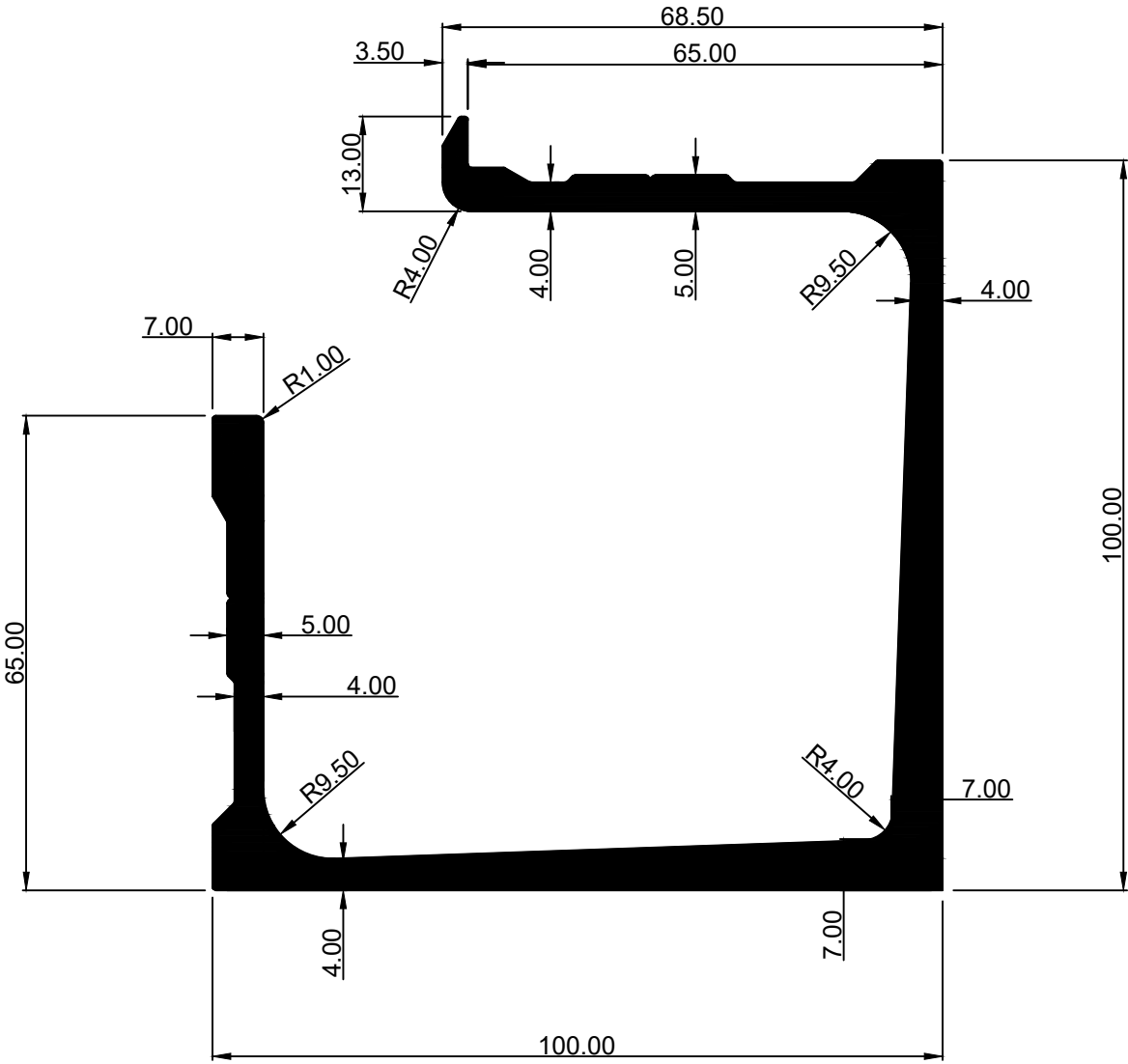

WEIGHT:- 4.7424 Kg/Mtr.

SHREENATHJI EXTRUSION

SECTION NO:- SE-1477

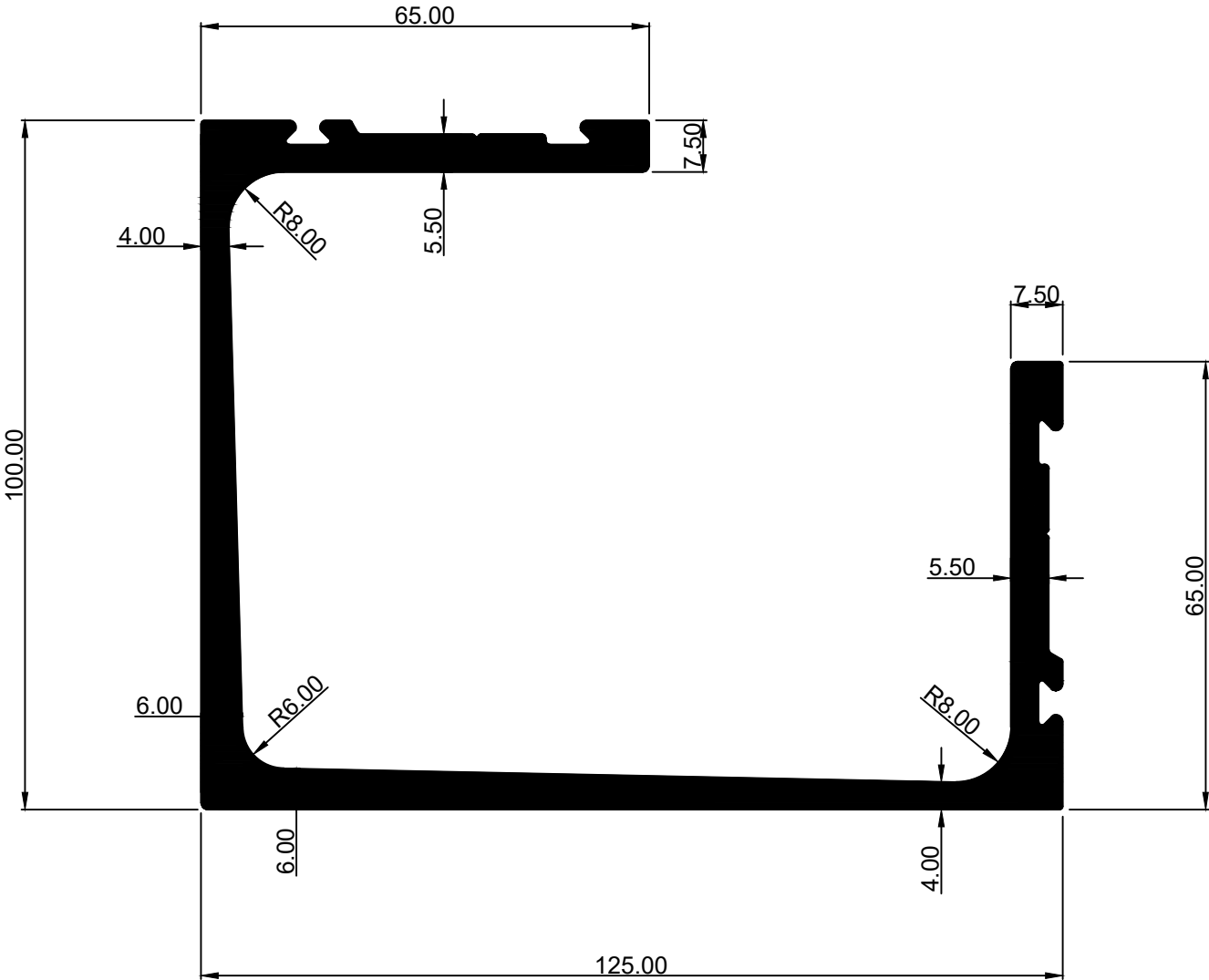

WEIGHT:- 4.9867 Kg/Mtr.

SHREENATHJI EXTRUSION

SECTION NO:- SE-1535

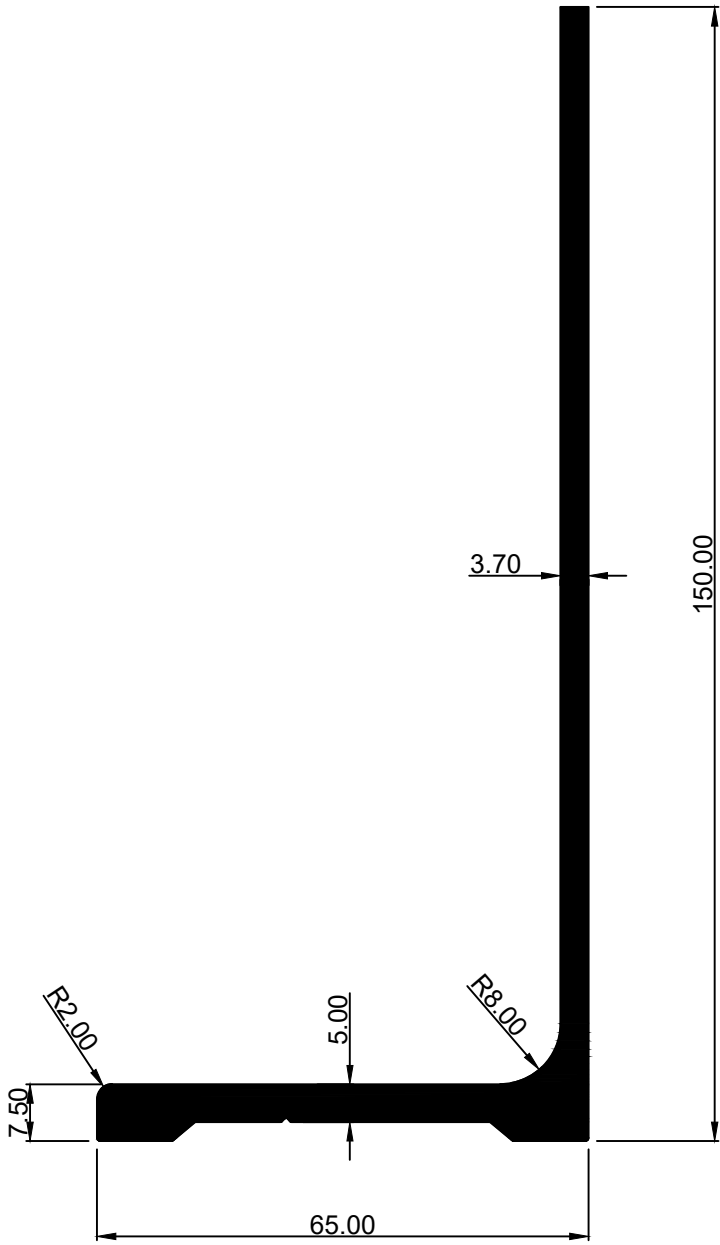

WEIGHT:- 2.4898 Kg/Mtr.

SHREENATHJI EXTRUSION

SECTION NO:- SE-1536

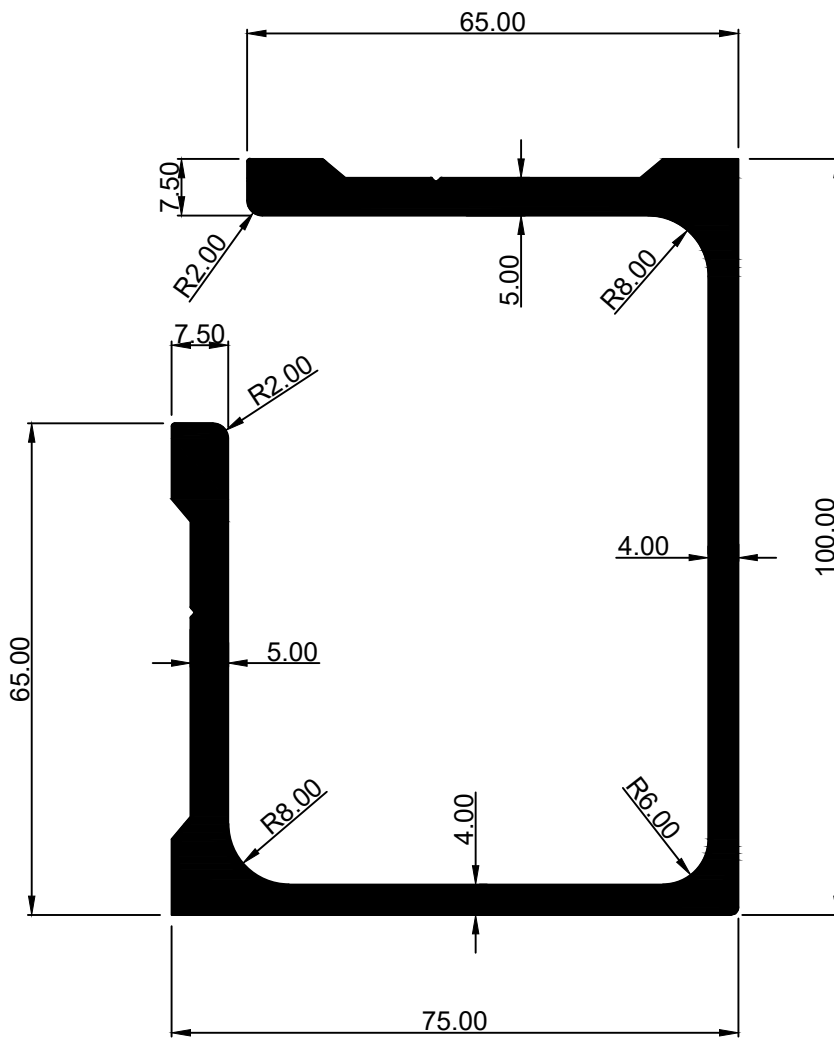

WEIGHT:-3.8379 Kg/Mtr.

SHREENATHJI EXTRUSION

SECTION NO:- SE-1537

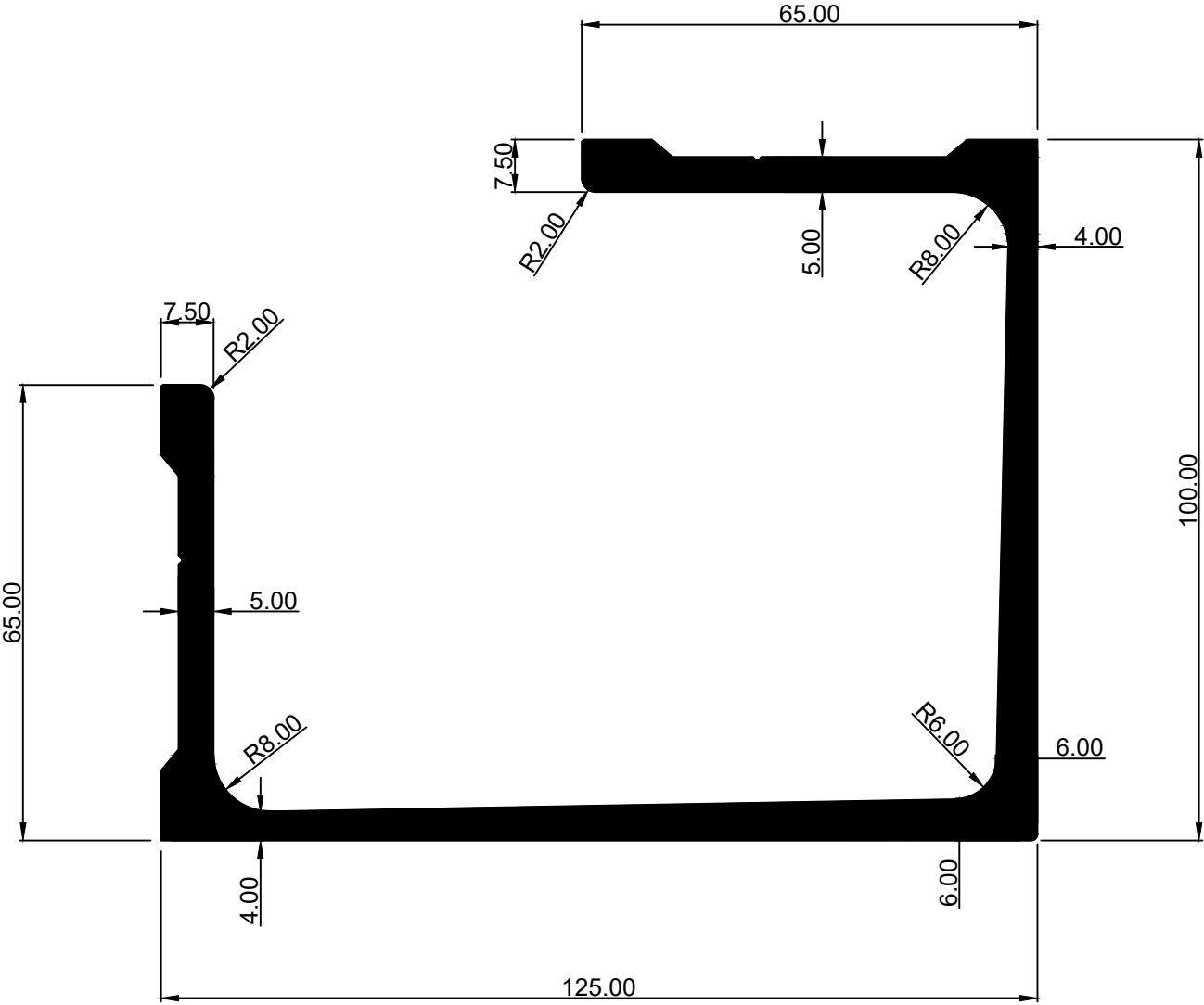

WEIGHT:- 4.9250 Kg/Mtr.

SHREENATHJI EXTRUSION

SECTION NO:- SE-1542

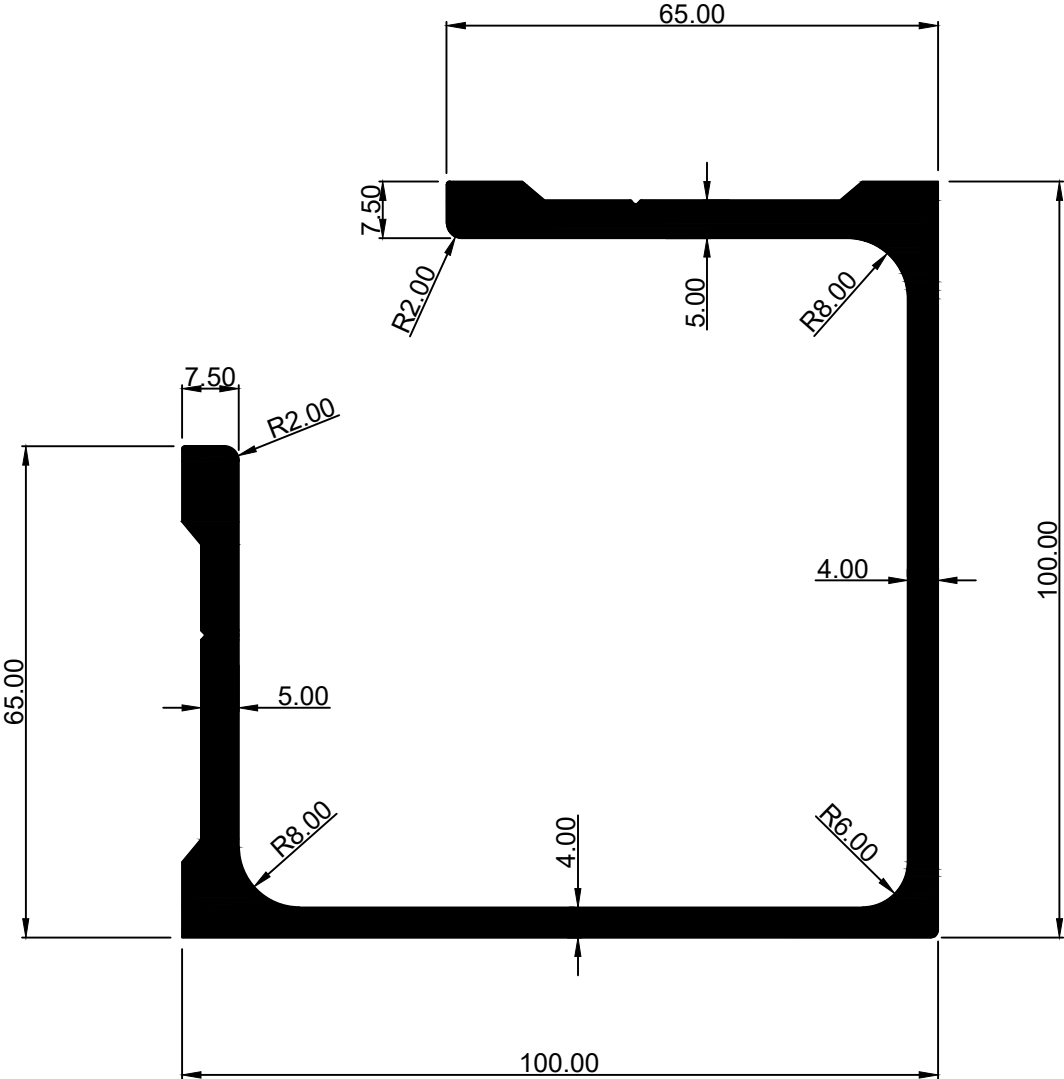

WEIGHT:- 4.1079 Kg/Mtr.

SHREENATHJI EXTRUSION

SECTION NO:- SE-1553

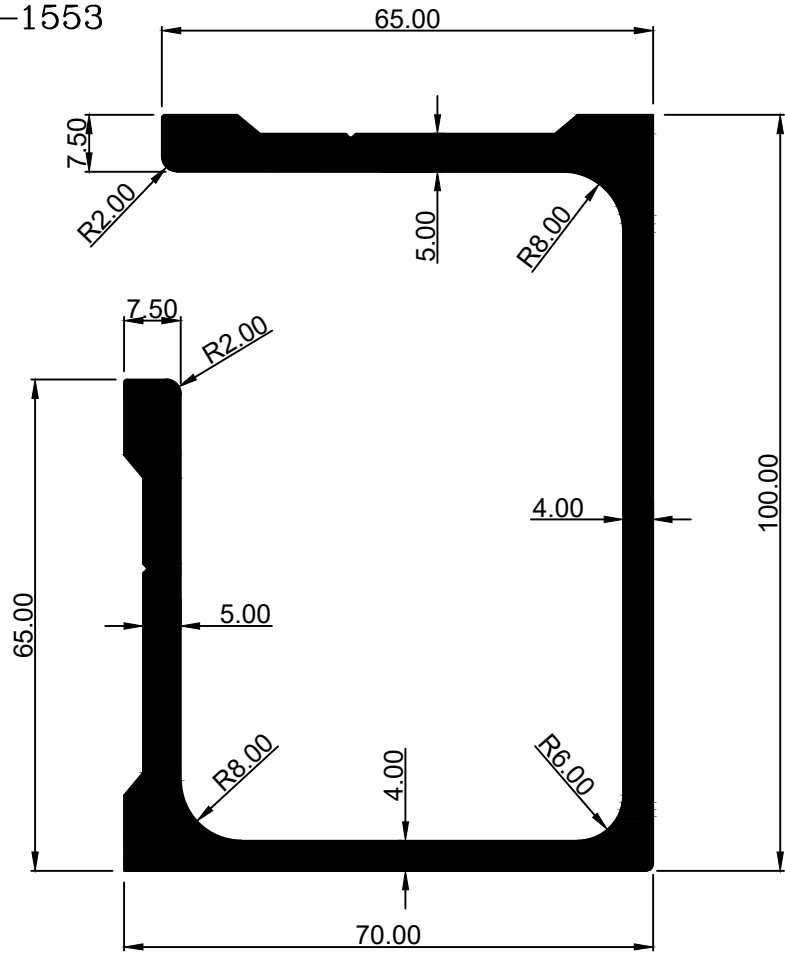

WEIGHT:- 3.7839 Kg/Mtr.

SECTION NO:- SE-1676

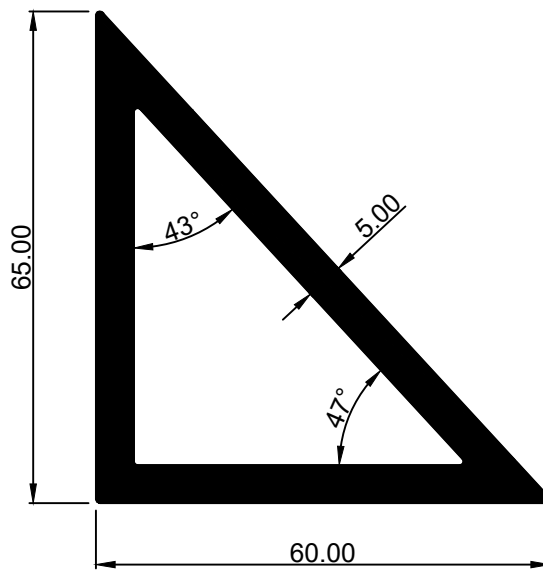

WEIGHT:- 9.2237 Kg/12'