

SHREENATHJI EXTRUSION

SEC. NO:-30545

SE-157

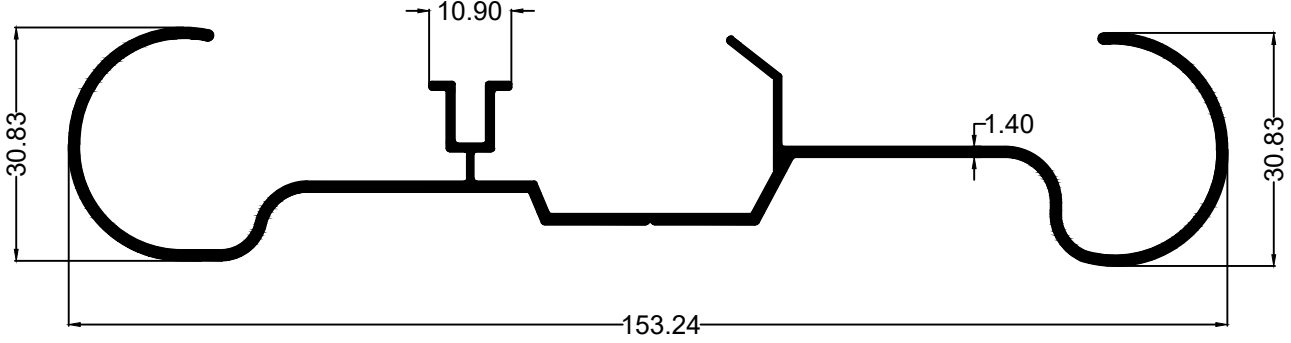

WEIGHT:- 3.876 kg/12'

SEC. NO:-16068

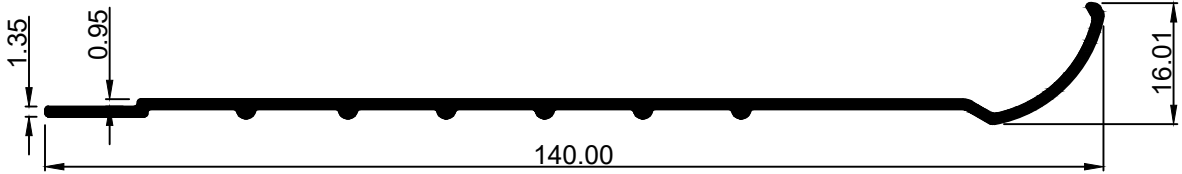

WEIGHT:- 2.144 kg/12'

SEC. NO:-16069

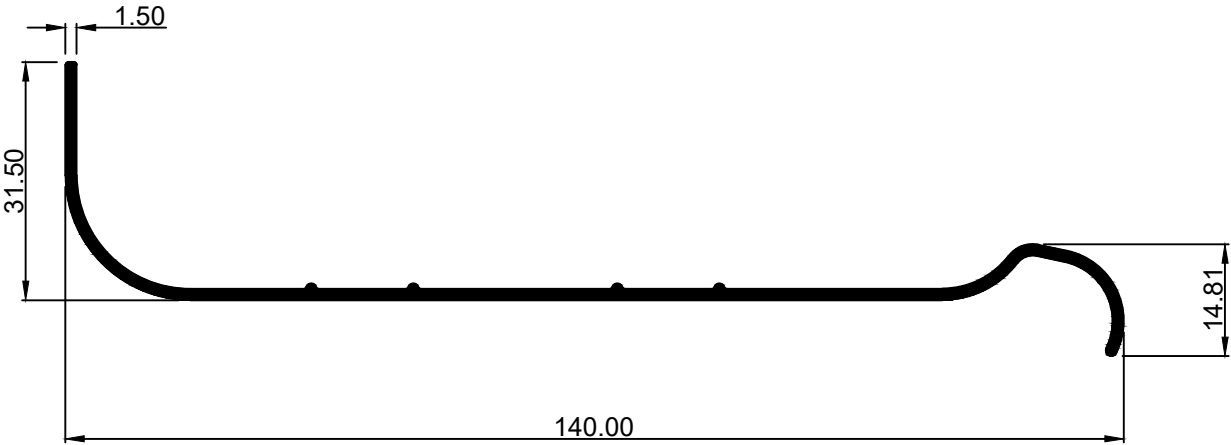

WEIGHT:- 2.610 kg/12'

SHREENATHJI EXTRUSION

SECTION No.:- SE-1319

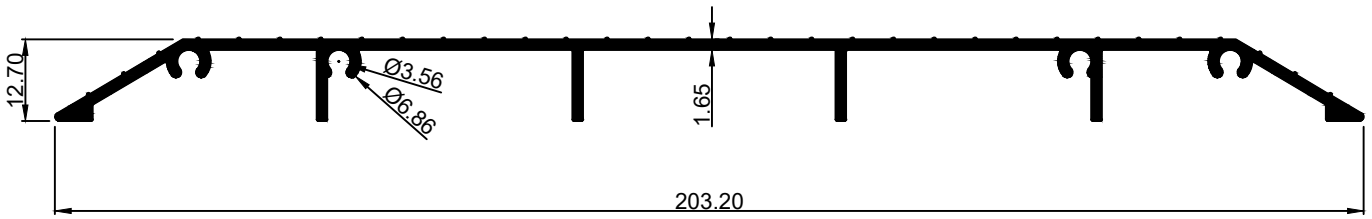

4.6999 Kg/12'

SECTION No.:- SE-1321

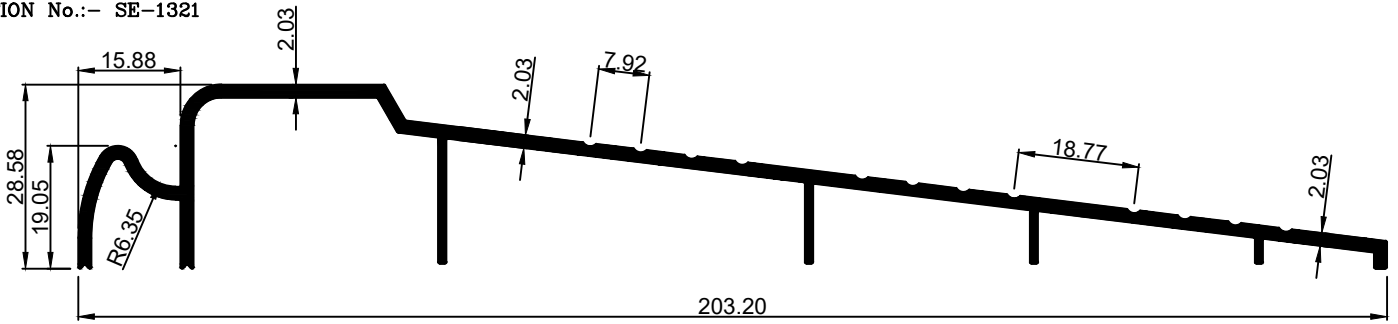

5.4907 Kg/12'

SECTION No.:- SE-1322

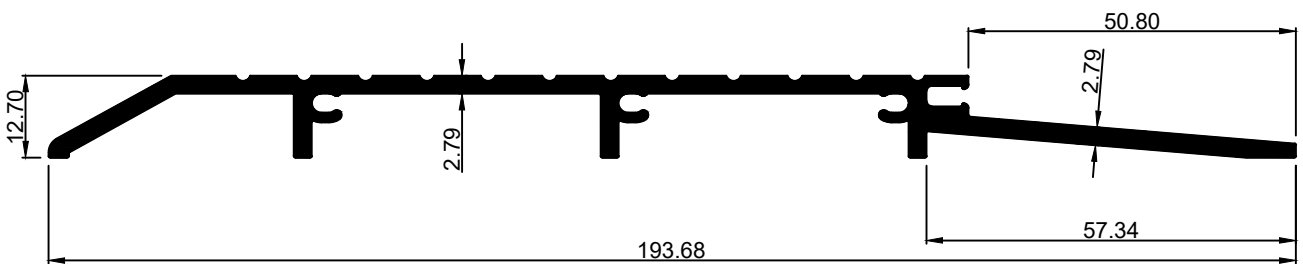

6.5011 Kg/12'

SHREENATHJI EXTRUSION

SECTION No.:- SE-1323

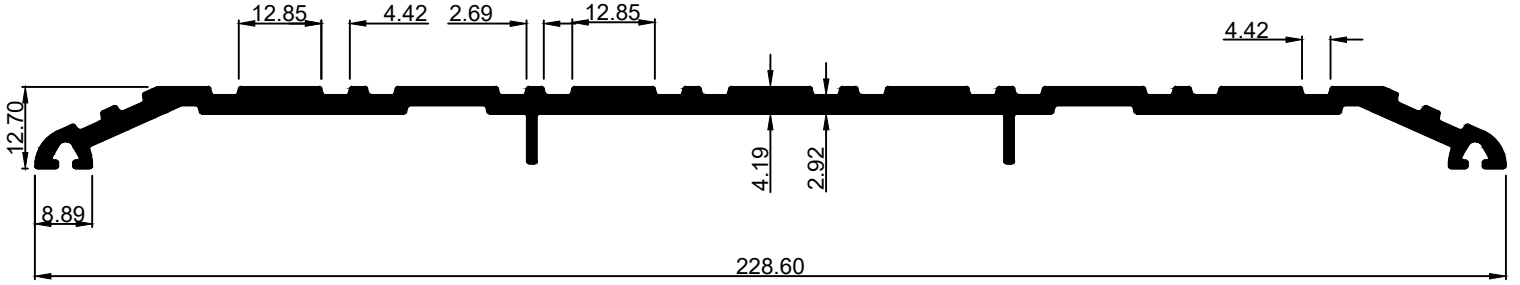

8.4764 Kg/12'

SECTION No.:- SE-1324

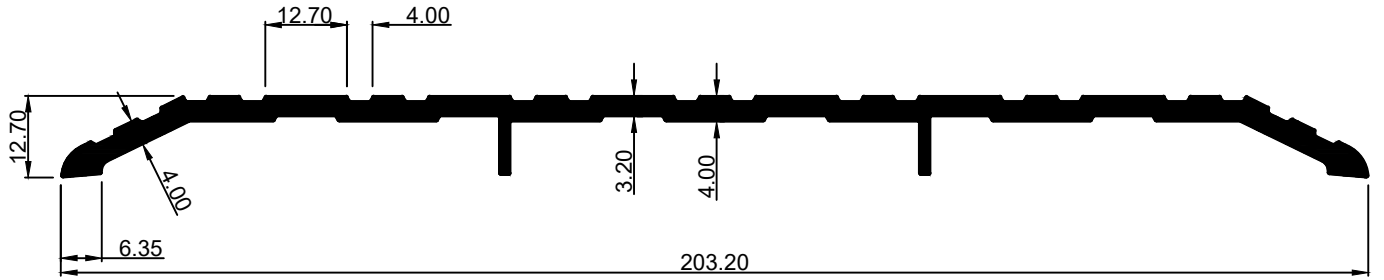

7.5403 Kg/12'

SECTION No.:- SE-1325

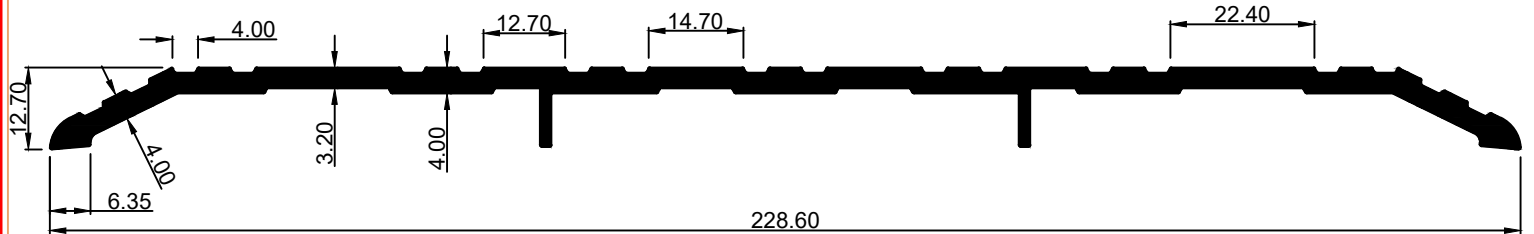

8.3931 Kg/12'

SHREENATHJI EXTRUSION

SECTION No.:- SE-1373

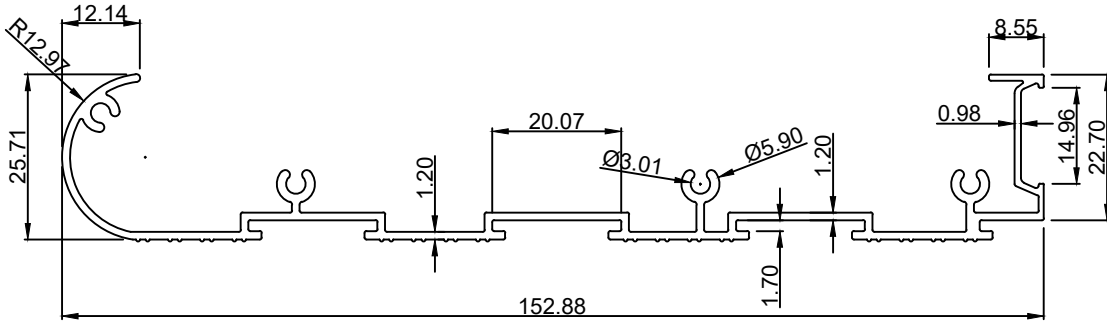

3.6422 Kg/12'

SECTION No.:- SE-1374

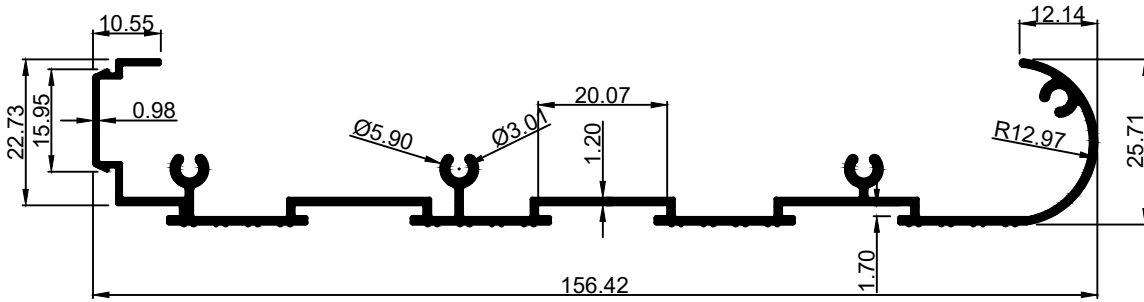

3.6479 Kg/12'

SECTION No.:- SE-1387

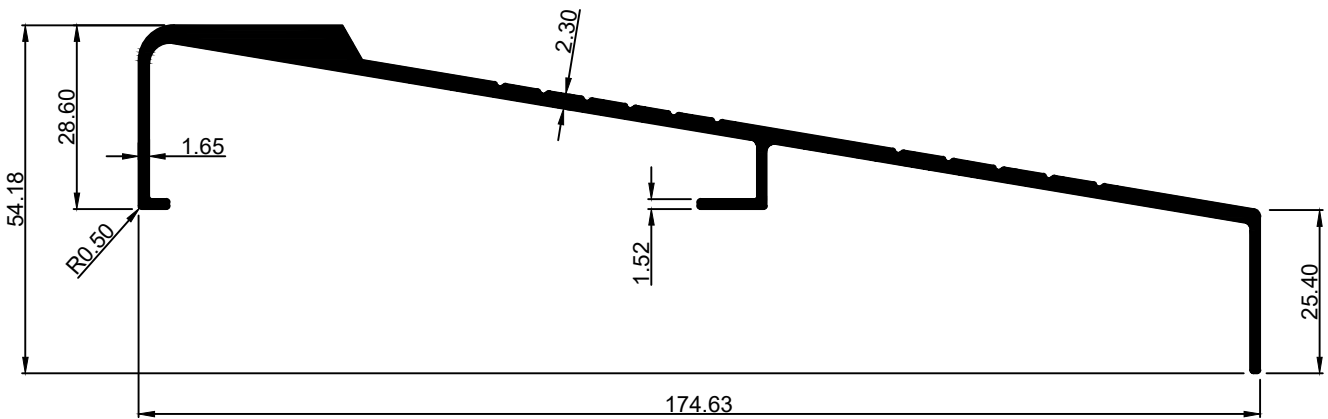

5.8397 Kg/12'

SHREENATHJI EXTRUSION

SECTION No.:- SE-1388

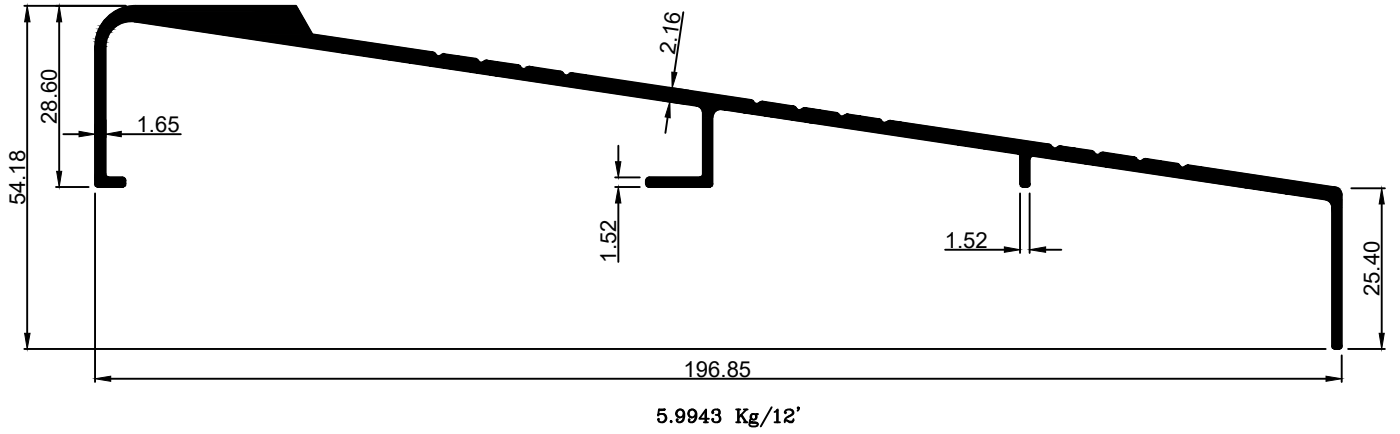

SECTION No.:- SE-433

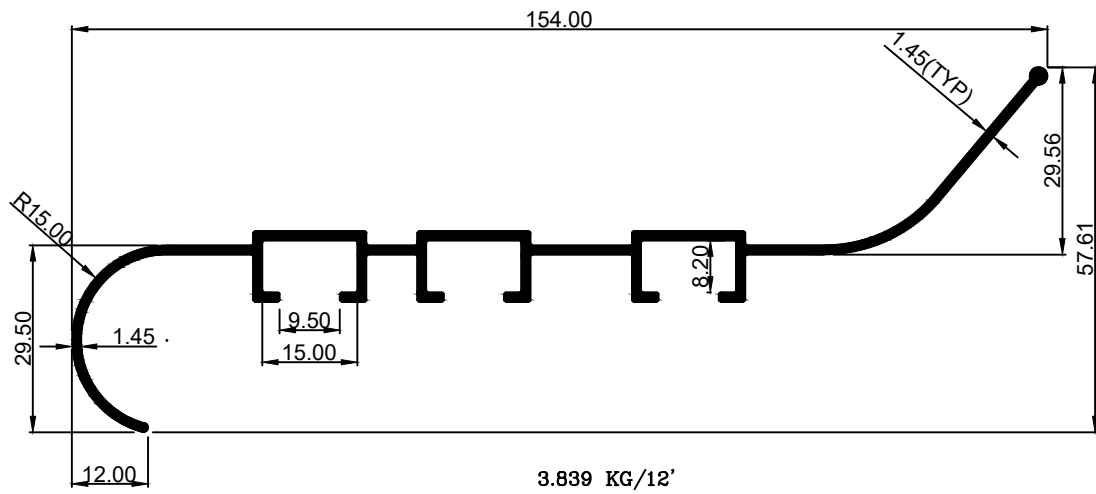

SECTION No.:- SE-434

