

# SHREENATHJI EXTRUSION

SEC. NO:-15301

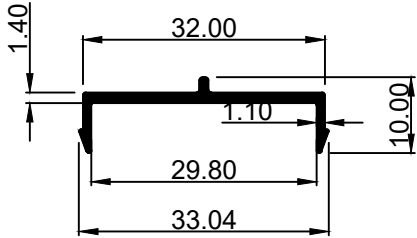

WEIGHT:- 0.612 kg/12'

SEC. NO:- P-01  
SEC. NO:-13471

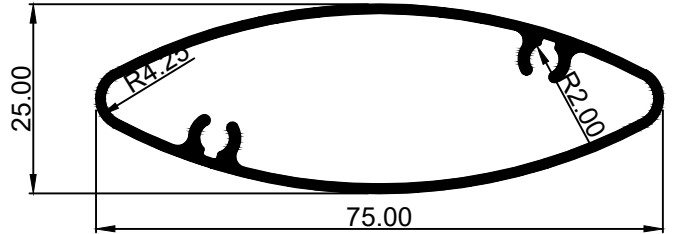

WEIGHT:- 2.250-2.550 kg/12'

SEC. NO:-15311

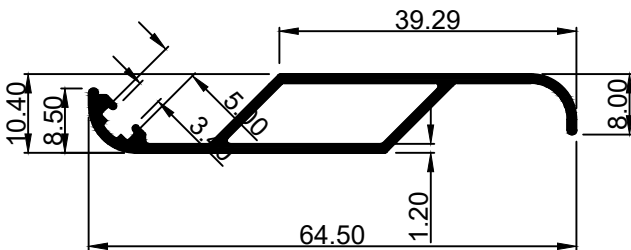

WEIGHT:- 1.400 kg/12'

SEC. NO:-15316

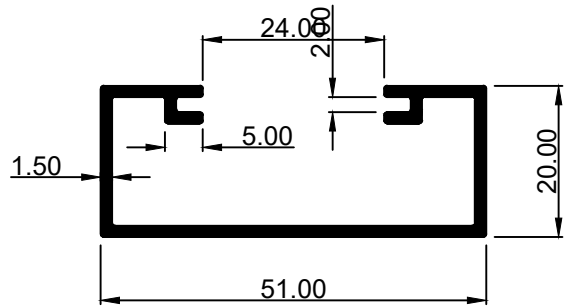

WEIGHT:- 1.866 kg/12'

SEC. NO:-15321

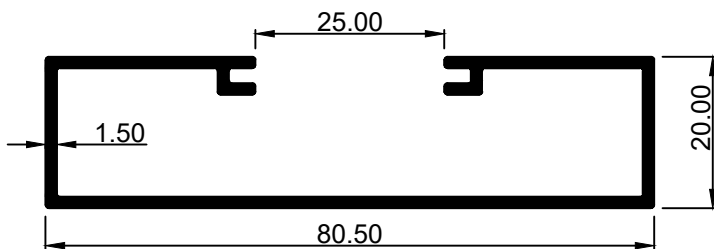

WEIGHT:- 2.726 kg/12'

SEC. NO:-13476

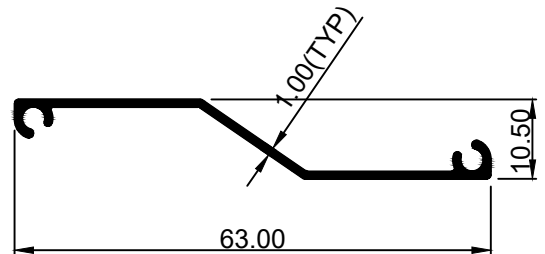

WEIGHT:- 0.800-1.000 kg/12'

SHREENATHJI EXTRUSION

SEC. NO:-15626

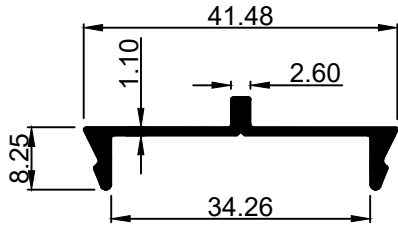

WEIGHT:- 0.844 kg/12'

SEC. NO:-15631

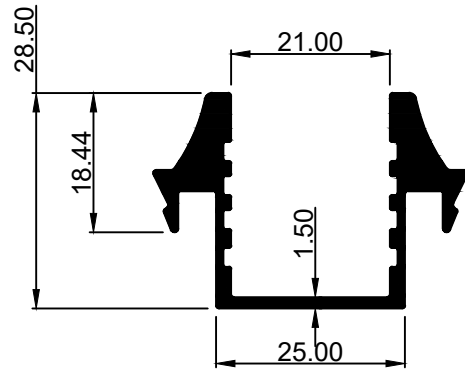

WEIGHT:- 2.451 kg/12'

SEC. NO:-15636

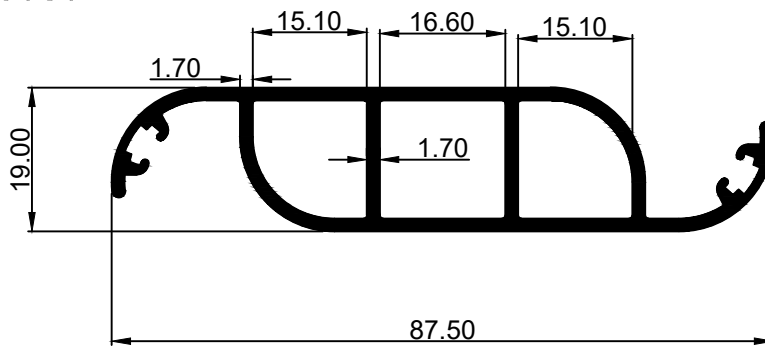

WEIGHT:- 3.640 kg/12'

SEC. NO:-15641

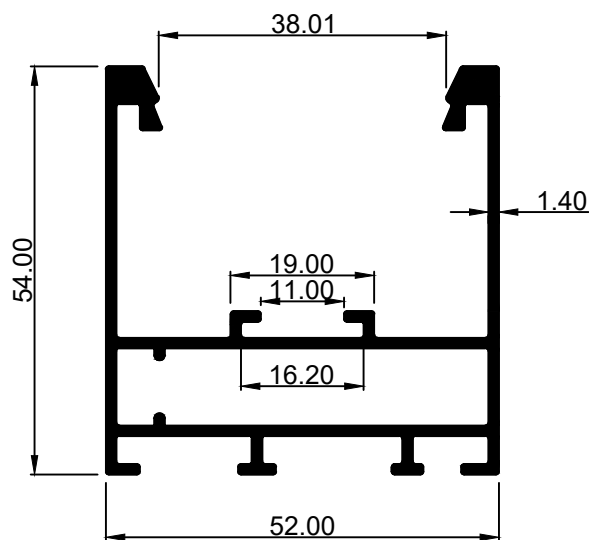

WEIGHT:- 4.023 kg/12'

SHREENATHJI EXTRUSION

SEC. NO:-30440

8212

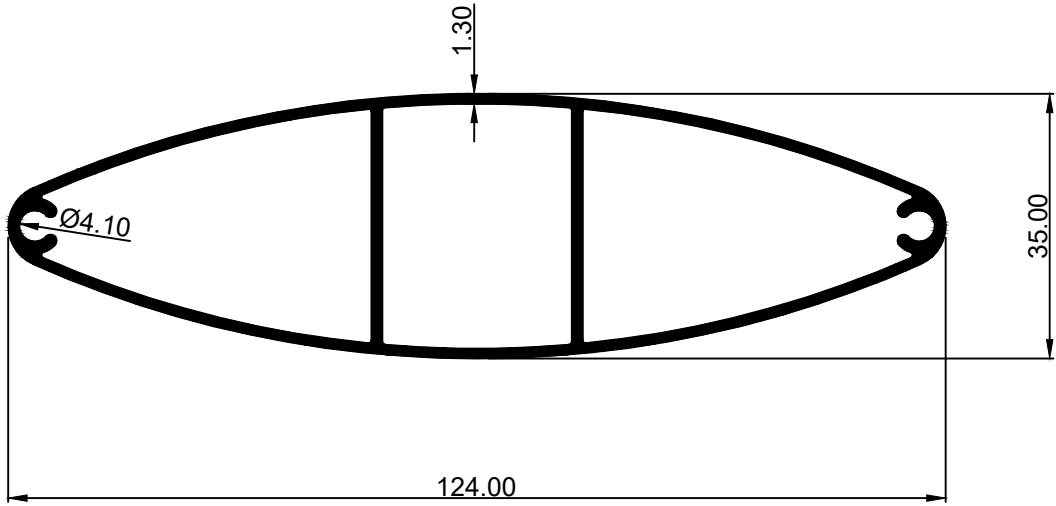

WEIGHT:- 4.552 kg/12'

SEC. NO:-30441

8198

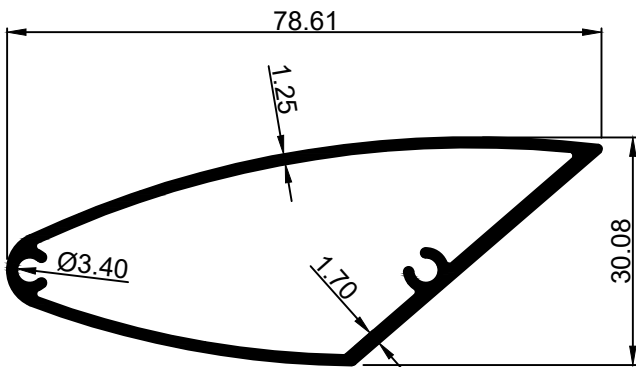

WEIGHT:- 2.500 kg/12'

SEC. NO:-16054

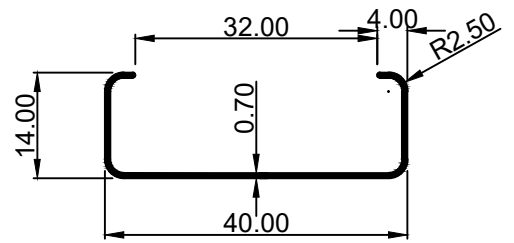

0.475 KG/12'

SEC. NO:-16352

AH-115

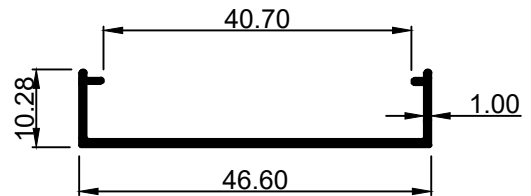

WEIGHT:- 0.718 kg/12'

# SHREENATHJI EXTRUSION

SEC. NO:-15937

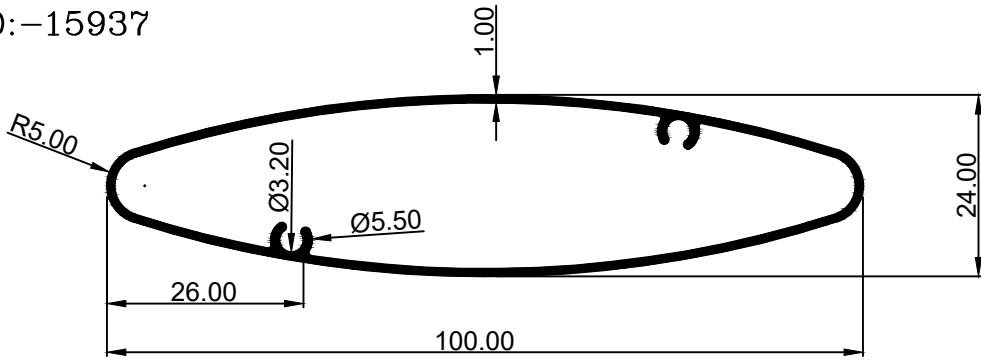

WEIGHT:- 2.266 kg/12'

SEC. NO:-30552

SE-208

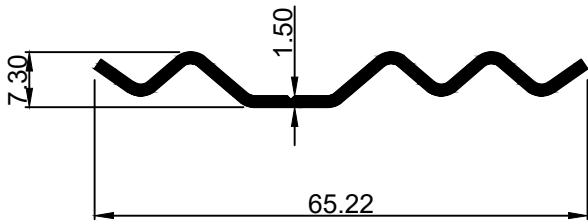

WEIGHT:- 1.126 kg/12'

SECTION No.:-SE-678

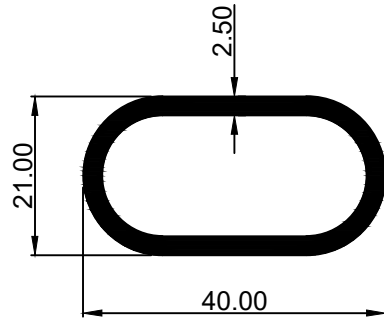

2.374 Kg/12'

SECTION No.:- SE-452

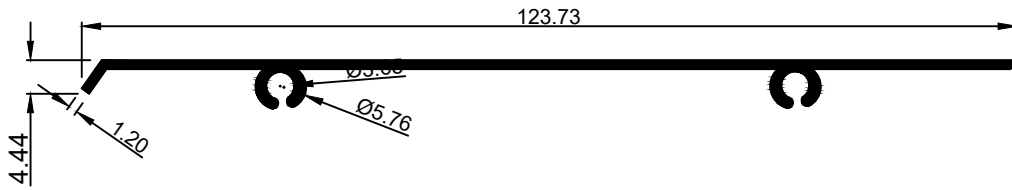

0.500 KG/Mtr.

SECTION No.:- SE-453

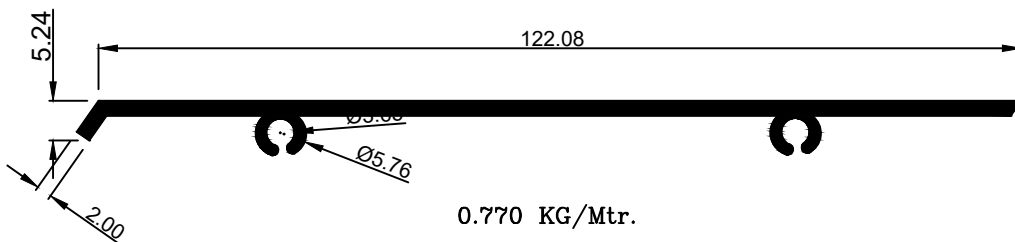

0.770 KG/Mtr.

# Shreenathji

# Extrusion

15136

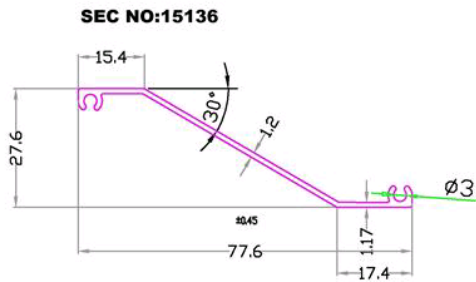

LOWERS

30440

SEC. NO:-30440

8212

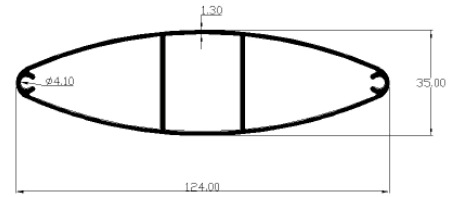

WEIGHT:- 4.552 kg/12'

LOWERS,HI FEB

30441

SEC. NO:-30441

8198

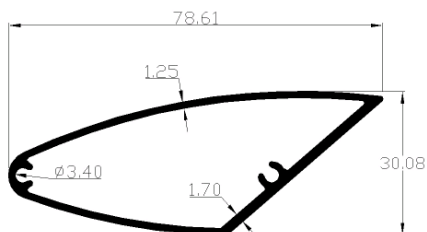

WEIGHT:- 2.500 kg/12'

LOWERS,HI FEB

8444

SEC NO:8444

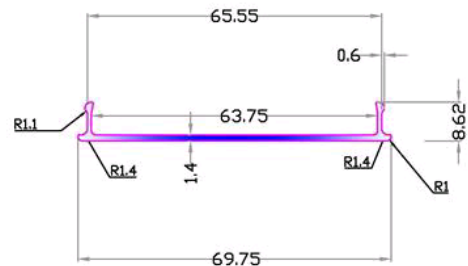

WEIGHT:1.120KG/12'

CURTAIN WALL,LOWERS

