

SHREENATHJI EXTRUSION

SEC. NO:-30217 P-103

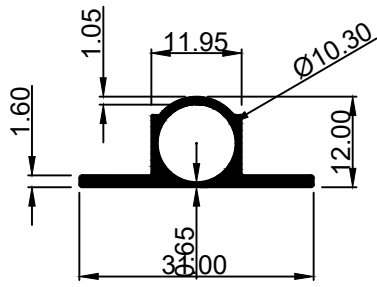

WEIGHT:- 0.750-0.950 kg/12'

SEC. NO:-30275 SE-42

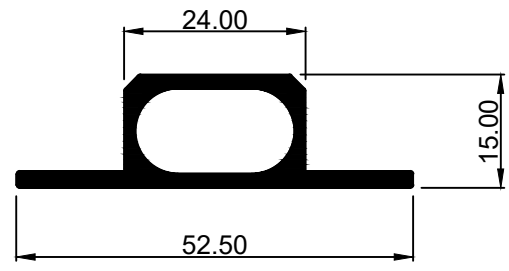

WEIGHT:- 2.077 kg/12'

SEC. NO:-30219 P-110

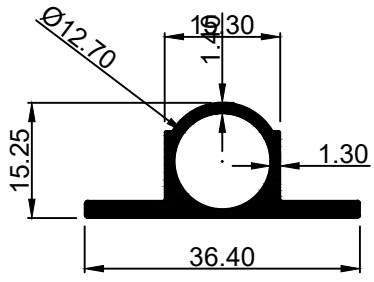

WEIGHT:- 1.300-1.600 kg/12'

SEC. NO:-30221

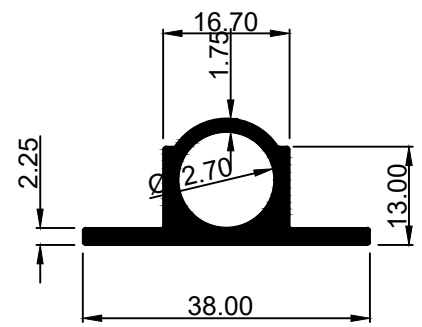

WEIGHT:- 1.700-2.000 kg/12'

SEC. NO:-30277 SE-44

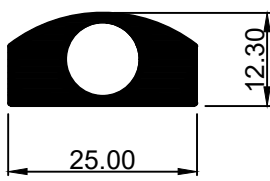

WEIGHT:- 1.971 kg/12'

SEC. NO:-30316 SE-99

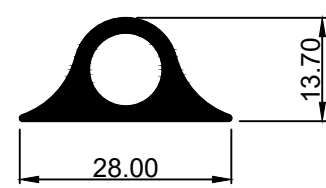

WEIGHT:- 1.360 kg/12'

SHREENATHJI EXTRUSION

SEC. NO:-30319

SE-100

SECTION No.:- SE-1080

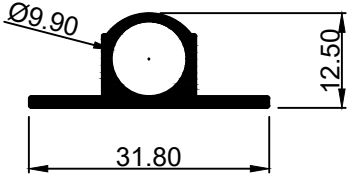

WEIGHT:- 0.940 kg/12'

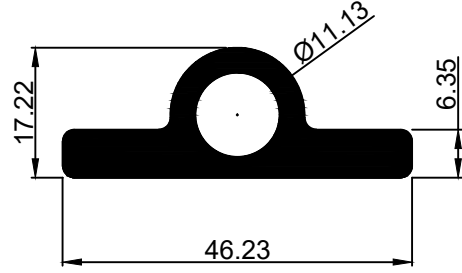

3.5049 Kg/12'